



Newland

SCANNING MADE SIMPLE



NQuire 750 Stingray micro kiosk user guide

Disclaimer

© 2020 Newland Auto-ID Tech. Co., Ltd. All rights reserved.

Please read through the manual carefully before using the product and operate it according to the manual. It is advised that you should keep this manual for future reference.

Do not disassemble the device or remove the seal label from the device, doing so will void the product warranty provided by Newland Auto-ID Tech. Co., Ltd.

All pictures in this manual are for reference only and actual product may differ. Regarding the product modification and update, Newland Auto-ID Tech. Co., Ltd. reserves the right to make changes to any software or hardware to improve reliability, function, or design at any time without notice. The information contained herein is subject to change without prior notice.

The products depicted in this manual may include software copyrighted by Newland Auto-ID Tech. Co., Ltd or third party. The user, corporation or individual, shall not duplicate, in whole or in part, distribute, modify, decompile, disassemble, decode, reverse engineer, rent, transfer or sublicense such software without prior written consent from the copyright holders.

This manual is copyrighted. No part of this publication may be reproduced, distributed, or used in any form without written permission from Newland.

Risk Warning Regarding Unauthorized System Updates:

You should use the Newland-provided tool to update this product's system. Modifying system files through installing a third-party ROM system or using any cracking method may result in product malfunction or data loss and this will void your warranty.

Newland Auto-ID Tech. Co., Ltd. reserves the right to make final interpretation of the statement above.

Newland Auto-ID Tech. Co., Ltd.
No.1, Rujiang West Rd., Mawei, Fuzhou, Fujian, China 350015
<http://www.newlandaidc.com>

Revision History

Version	Description	Date
V1.0	Initial release.	Dec. 10th, 2019
V1.1	Update with PN and file format	June.24th 2020

Table of Content

Chapter 1 Device Instruction&Installation	1
Hardware Instruction	1
1. LED Indicator	3
2. SD/SIM Card Slot/Cover	3
3/4/5.Key	3
6. Front Camera	4
7. Expansion Slots & Add-on modules	4
8. Speaker	5
9. Vesa Mount Holes.....	5
10. DC-In Jack	6
11. Barcode Scanner	6
12. Control I/O Ports & Cover	6
13/14/15. Generic I/O Ports	10
16. Power Switch	10
Chapter 2 Accessory & Installation	11
VESA Wall Mount.....	11
Chapter 3 Feature Programming.....	12
Home Screen	12
Change wallpaper	12
Add Widgets.....	15
System Bar	17
Navigation Buttons.....	17
Status Notifications	18
Applications	19
Language & Input Method.....	20
Date & Time	21
Volume	22
Brightness	23
Schedule Power On/Off	24
Wi-Fi	26
Ethernet.....	27
Bluetooth	28
Virtual Keyboard.....	29
Take Photos	31
Surf Online	32
Play Media.....	33
Install & Uninstall Apps	34
Install Apps	34

Uninstall Apps	38
Reset to Factory Default	40
Chapter 4 Important Safety and Handling Information	42

Chapter 1 Device Instruction & Installation

Hardware Instruction

Top

SD/SIM slot w/cover

Exit Key

(Up/Down)Key

(Vol+/Vol-)Key



Left

Front

Front Camera

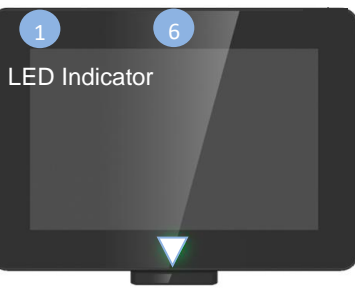

Rear

Vesa Mount Holes

Expansion Slot

Speaker



Right



Barcode Scanner

Bottom

Power Switch

Type A USB Port

Micro USB Port



RJ45 Ethernet Port

DC in Jack

Barcode Scanner

-
1. **LED Indicator**
 2. **SD Card Slot / Cover:** support external SD card
 3. **Exit Key:** return to the previous page
 4. **Up / Down Key:** navigate up/down to select an item
 5. **Vol+ / Vol- Key:** adjust the system volume
 6. **Front Camera:** embedded 5M pixels
 7. **Expansion Slot:** install optional add-on modules
 8. **Speakers:** dual audio output
 9. **VESA75 Mounting Holes:** max. screw depth 4.5mm from mounting surface
 10. **DC-In Jack:** powered by 12V/2A DC input
 11. **Barcode Scanner:** 2D barcode scanner to scan barcode
 12. **Control I/O Port Cover:** cover for GPIO and RS-232 ports
 13. **10/100Mbps Ethernet Port:** RJ45 connector supporting Ethernet connection
 14. **USB Host Port:** support USB 2.0 Host type A
 15. **Micro-USB OTG Port:** USB 2.0, Micro-USB type B jack, OTG
 16. **Power Switch:** switch power ON/OFF

Hardware Instruction & Operations (Installation & Uninstallation)

1. LED Indicator

Green	Power supply is on.
Light Off	Power supply is off.

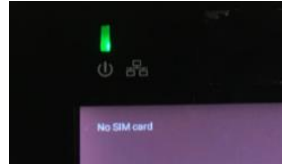

2. SD/SIM Card Slot/Cover

Support external SD card up to 128GB.

INSTALLATION:

- 1) Release the screw on SD/SIM card cover.
- 2) Remove SD/SIM card cover.
- 3) Insert SD/SIM card into the push-push SD/SIM card slot.



REMOVAL:

- 1) Push SD/SIM card inside the slot, release press force suddenly to let SD/SIM card popped out from the slot.
- 2) Insert cover and fix it by screw.

3/4/5.Key

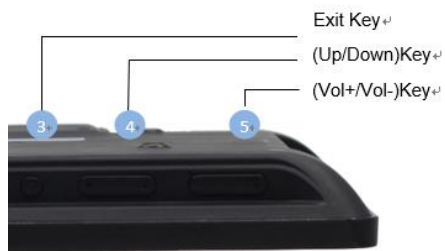

6. Front Camera

It is a build-in camera with 5 mega-pixel.

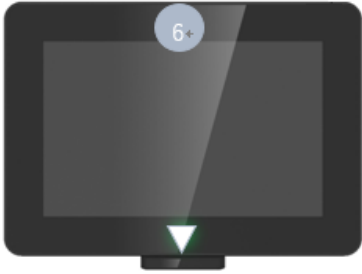

7. Expansion Slots & Add-on modules

For add-on modules like RFID and MSR,4G-TLE.

- 1 5V
- 2 D-
- 3 D+
- 4 GND
- 5 RXD
- 6 TXD
- 7 GPI01
- 8 GPI02



- 1 GPI02
- 2 GPI01
- 3 TXD
- 4 RXD
- 5 GND
- 6 D+
- 7 D-
- 8 5V



ADD-ON MODULES

13.56M RFID	125K RFID	MSR Module	4G-LTE

INSTALLATION

- 1) Align the positioning bumps on module with the pits on main device and gently press down until they are fully inserted.
- 2) Fix module on main device by screws.



8. Speaker

Dual audio output.



9. Vesa Mount Holes



10. DC-In Jack

Plug the power adapter into the power jack.



Power Jack



Plug with Power adapter

11. Barcode Scanner

Barcode engine is set up in auto mode as default setting. LED will light up when any object shows in front of barcode scanner within proper distance, and barcode engine will automatically scan when a barcode showed within proper distance.

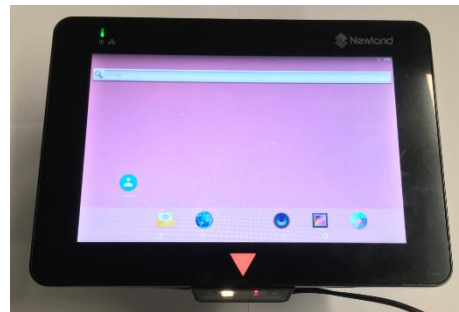

12. Control I/O Ports & Cover

There are control IO ports (RS-232 & GPIO) under the Control IO cover (#12 in Device Instruction). Loosen and remove screw to release the cover. Then take out the cover.

RS-232 port pinout (PIN1-PIN6):
GND, RX, TX, GND, 5V, 5V.



GPIO port pinout (PIN1-PIN8): INPU_VOD (GPIO0_31), INPU_VOC (GPIO0_30), VOB_OUT (GPIO0_29), VOA_OUT (GPIO0_15), INPUT_GND, INPUT_GND, N/A, INPUT_VCC_In.

The NQuire can be connected to devices, such as LED lamp, door lock or access control system via its GPIO port.

Call the NQuire's GPIO control API: Reference

Nq750_interface_api.jar and then import com.android.nq750.NQManager in your code.

Introduction to the NQManager class:



API	Description	Parameters	Type of Return Value	Return Value
setdoorThreshold (String value)	Set GPIO pin state	150: Set VOA_OUT (GPIO0_15) to high 151: Set VOA_OUT (GPIO0_15) to low 290: Set VOB_OUT (GPIO0_29) to high 291: Set VOB_OUT (GPIO0_29) to low 1011: Enable UART 1010: Disable UART	boolean	true: success false: failure
getdoorData()	Read the state of INPU_VOC (GPIO0_30) and INPU_VOD (GPIO0_31)	Null	String	00: GPIO0_30 high, GPIO0_31 high 01: GPIO0_30 high, GPIO0_31 low 10: GPIO0_30 low, GPIO0_31 high 11: GPIO0_30 low, GPIO0_31 low

GPO circuit example:

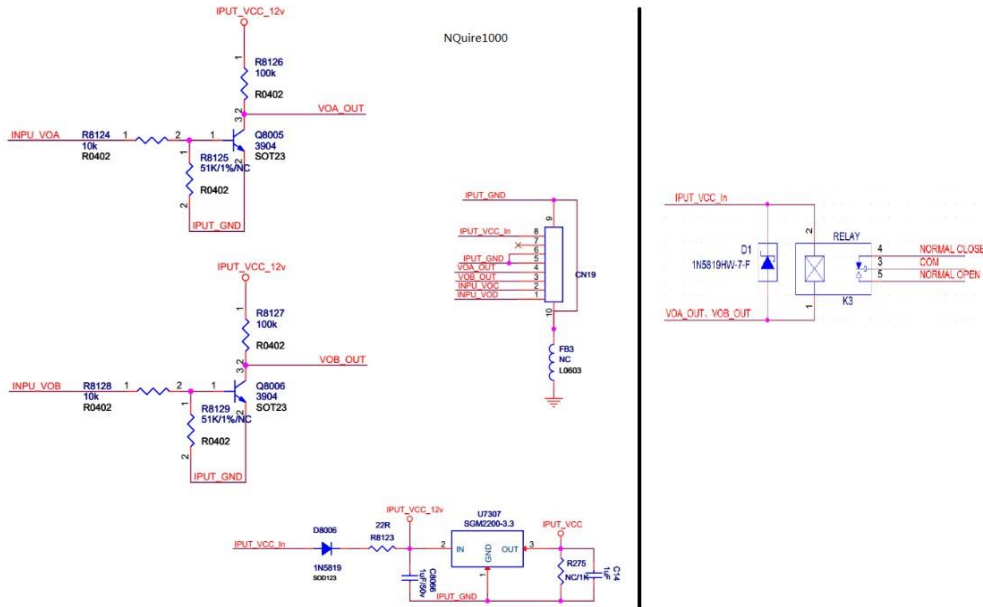

GPI circuit example:

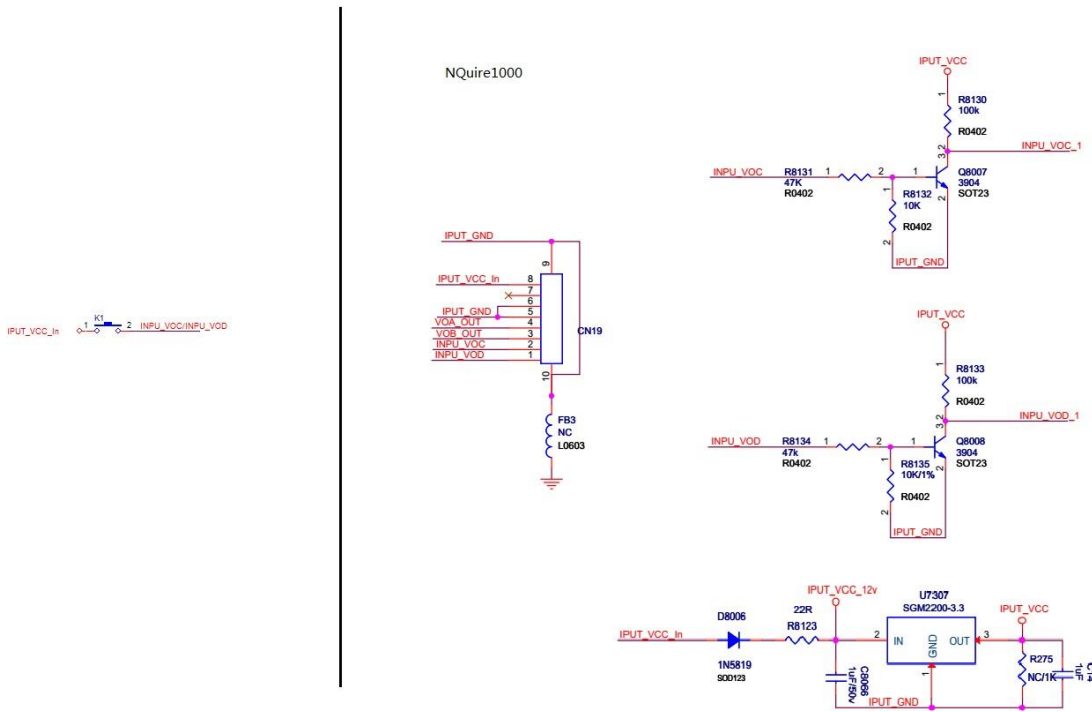

Control logics:

NET NAME	CONDITION	RESULT	REMARK
INPU_VOC	INPU_VOC=IPUT_VCC_In	GPIO0_30=L	INPUT
	INPU_VOC=IPUT_GND	GPIO0_30=H	
INPU_VOD	INPU_VOD=IPUT_VCC_In	GPIO0_31=L	
	INPU_VOD=IPUT_GND	GPIO0_31=H	
VOA_OUT	GPIO0_15=H	VOA_OUT=IPUT_GND	OUTPUT
	GPIO0_15=L	VOA_OUT=IPUT_VCC_In	
VOB_OUT	GPIO0_29=H	VOB_OUT=IPUT_GND	
	GPIO0_29=L	VOB_OUT=IPUT_VCC_In	

Electrical requirements:

$12V \leq \text{IPUT_VCC_In} / \text{INPU_VOC} / \text{INPU_VOD} \leq 24V$

13/14/15. Generic I/O Ports



16. Power Switch

- 1) Switch on to boot up device.
- 2) By default, power switch is in **ON** position.



Chapter 2 Accessory & Installation

VESA Wall Mount

Installation & Operation

1. Select a mounting location that is convenient for operation.
2. Remove the screw attaching the bracket to the chassis of the VESA 75 mount.
3. For wall mounting, install the four plastic wall anchors in a wall and then secure the bracket of VESA 75 mount to the wall using the four large screws. For countertop/shelf mounting, secure the bracket of VESA 75 mount to a countertop/shelf using the four large screws.
4. Complete all wire/cable connections to the NQuire. Secure the chassis of VESA 75 mount to the back of the NQuire using the four small screws. **Note that the depth of screw insertion into the NQuire must not exceed 4.5mm.**
5. Attach the bracket back to the chassis with the screw that was removed in step 2.

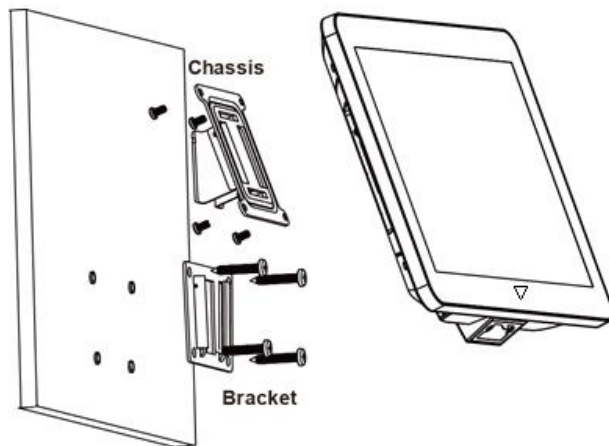

Chapter 3 Feature Programming

Home Screen

On the home screen, you can long-tap on any blank area to change the wallpaper or drag widgets to desktop.

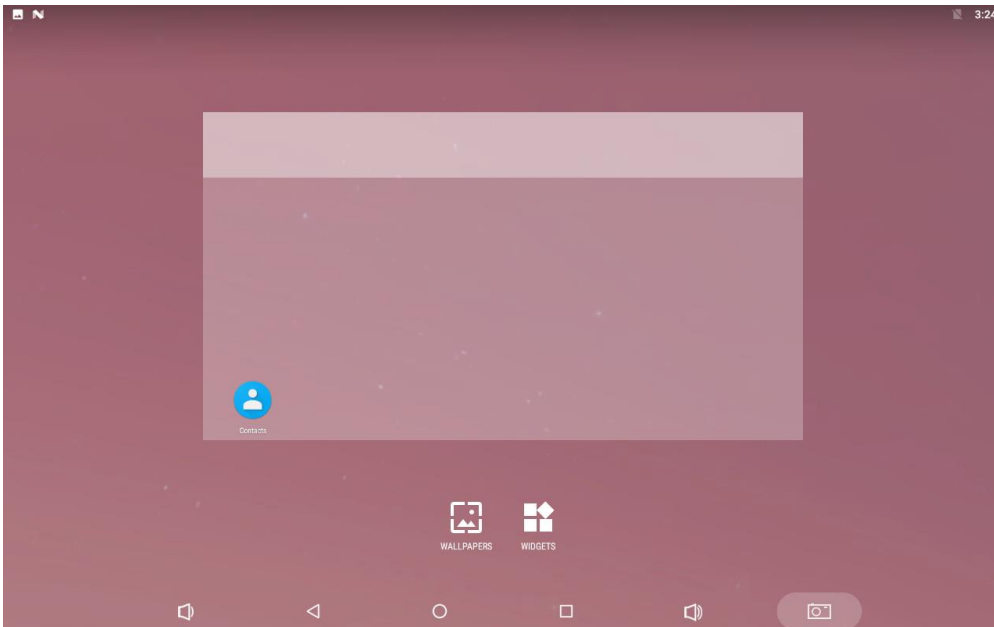

Change wallpaper

1. Tap  WALLPAPERS

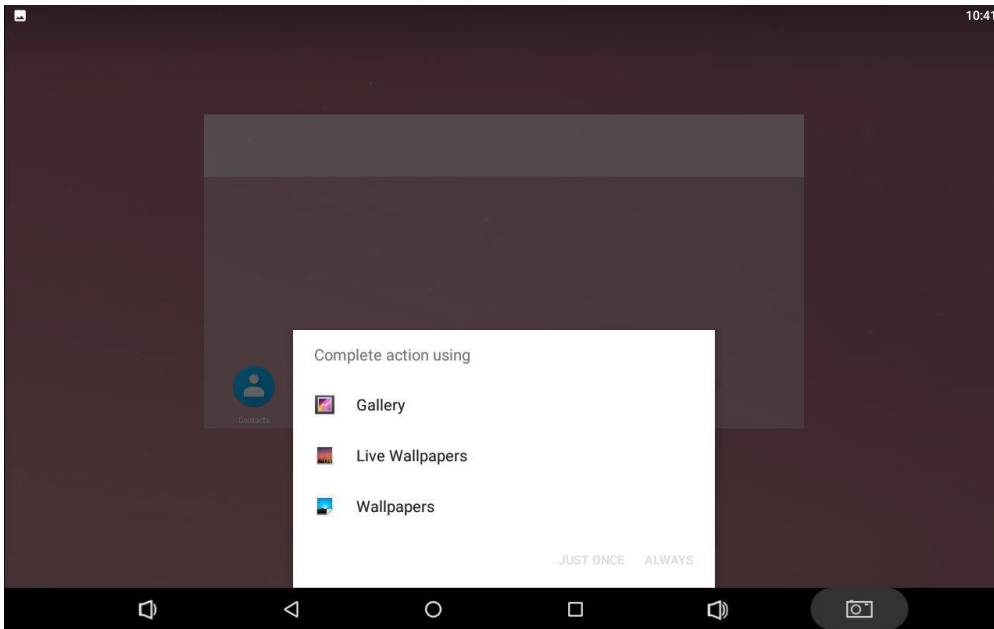

2. Tap **"Wallpapers"**.

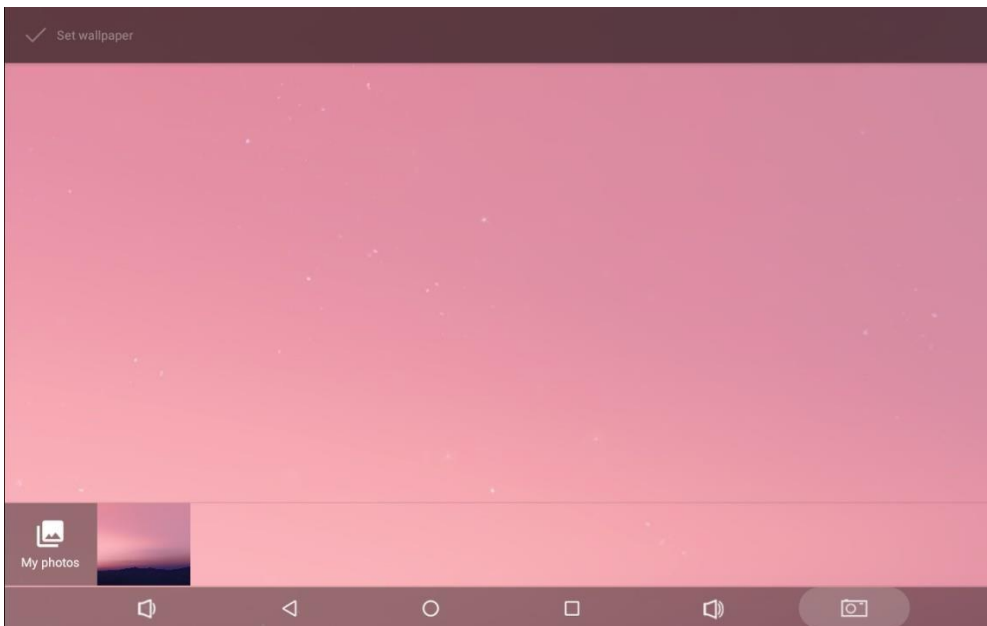

-
3. Select the image you want as your wallpaper.

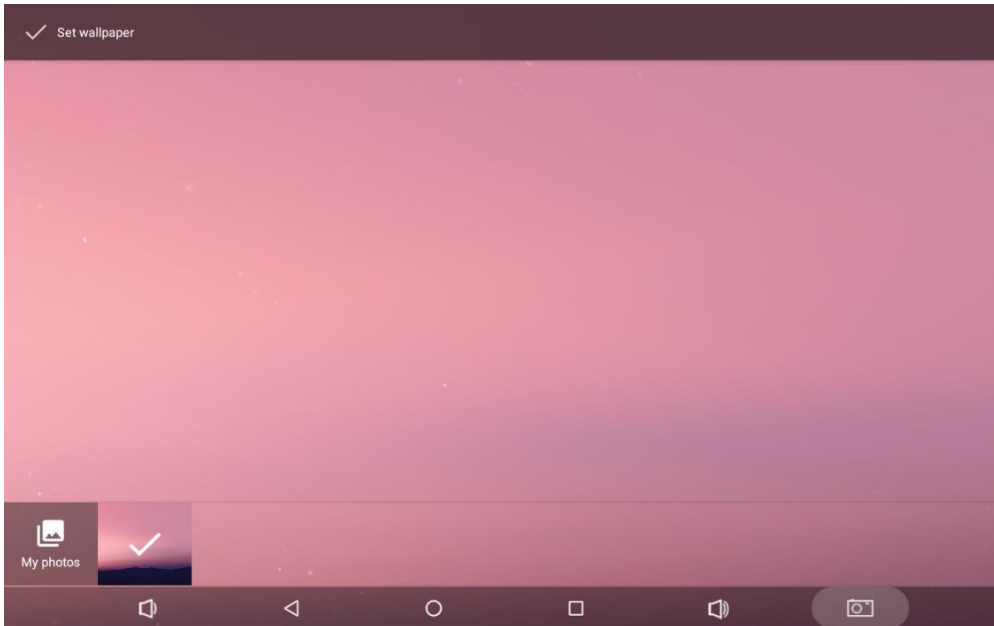

4. Tap "**Set wallpaper**" on the upper-left corner of the screen then "**Home screen**" to apply the new wallpaper.

Add Widgets

1. Tap  WIDGETS.

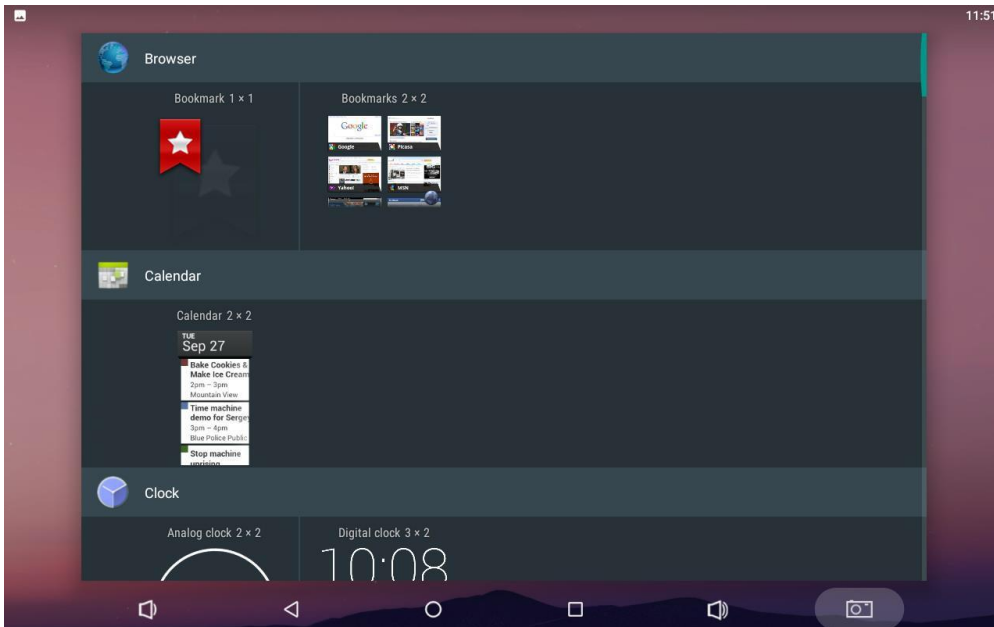

2. Long-tap on a widget and drag it to desktop.

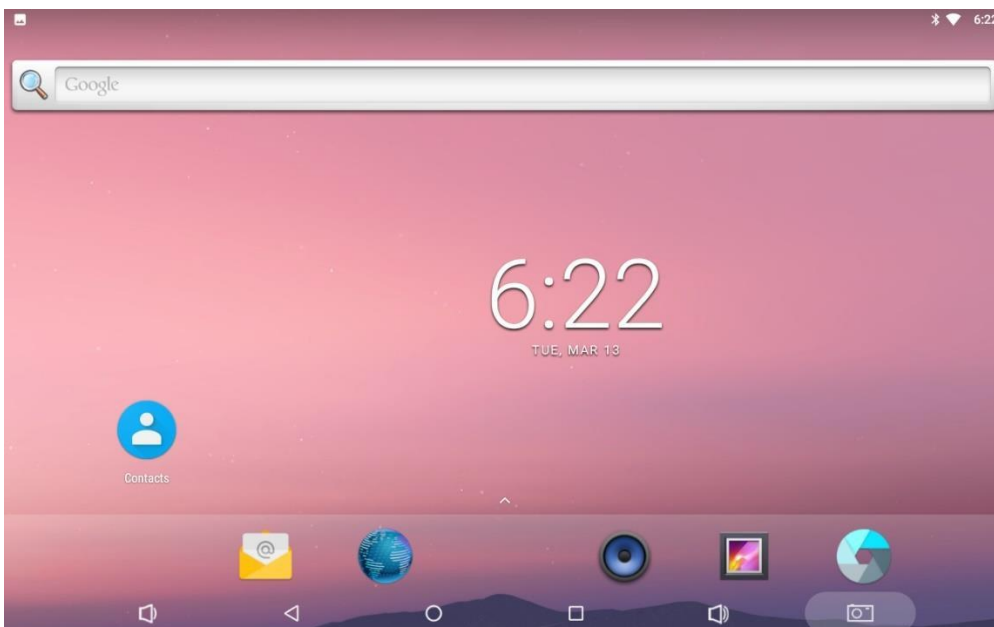

3. If you want to remove an icon, long-tap on the widget and then drag it onto **"X Remove"** at the top of the screen.

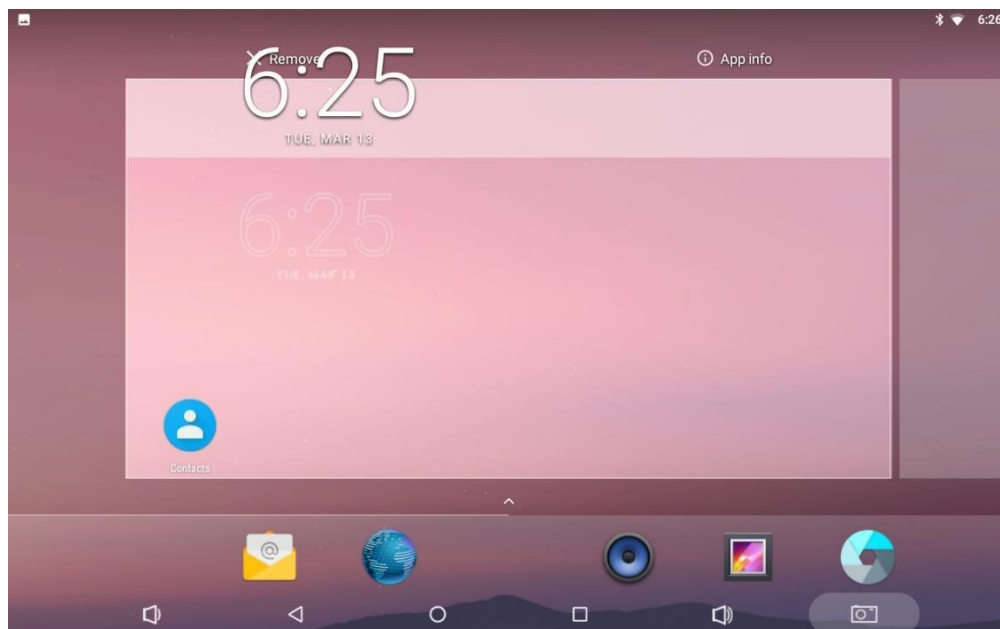

System Bar

Navigation Buttons

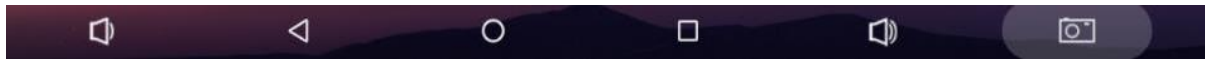

1 2 3 4 5 6

1. **Volume-**: Decrease the system volume.
2. **Back**: Return to the previous page.
3. **Home**: Return to the home screen.
4. **Recents**: Switch between recently used apps.

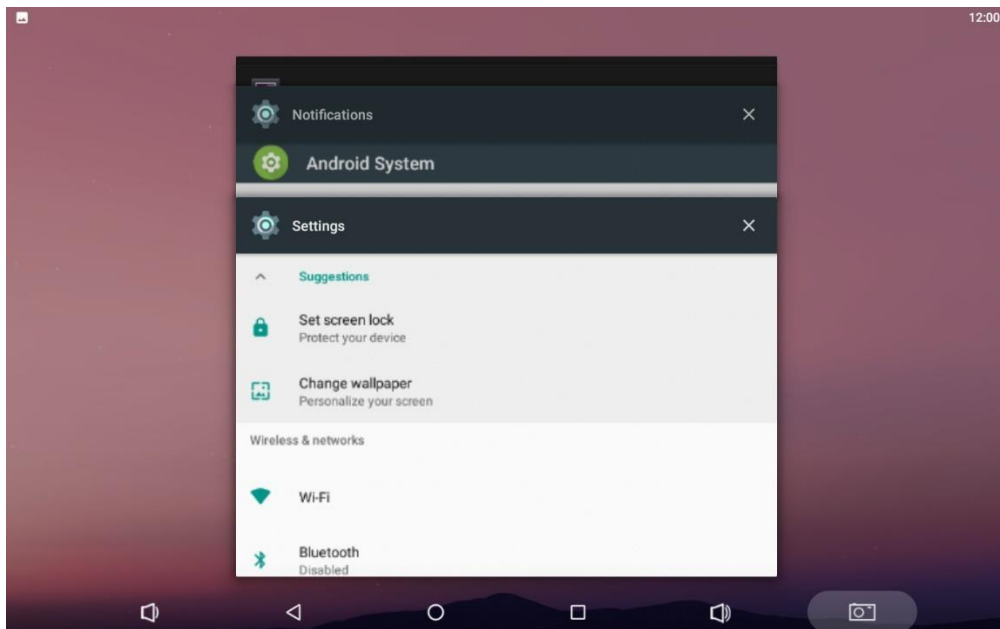

To remove an app from the list, swipe the app item left or right or tap “X” in the upper-right corner of the app window to remove it.

5. **Volume+**: Increase the system volume.
6. **Screenshot**: Take a screenshot.

Status Notifications



Status bar at the top of the screen displays system status, such as time, Wi-Fi, SIM card and USB connection, etc.

Pull down the status bar to open the status window.

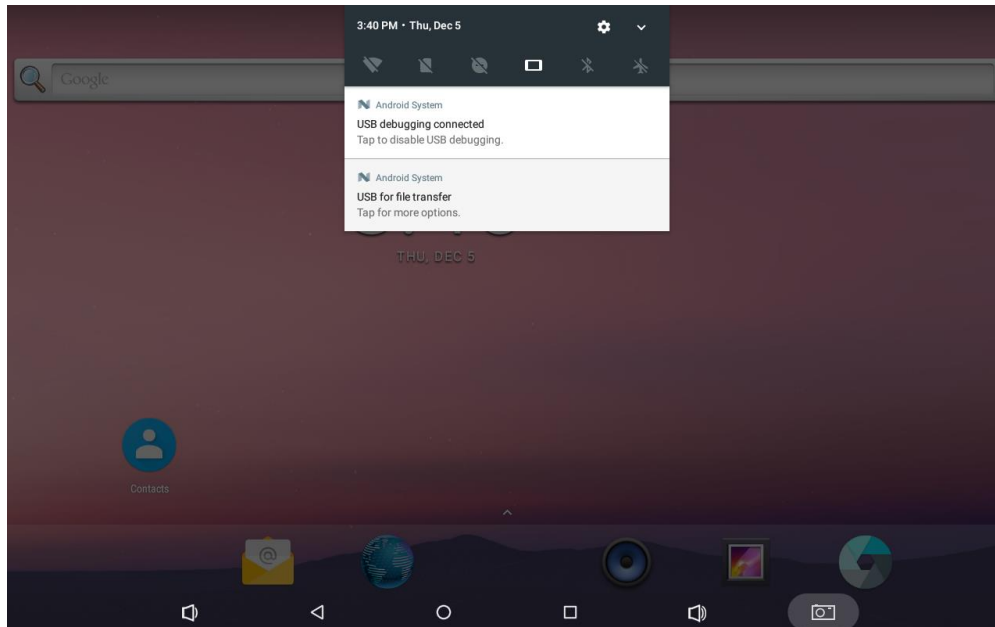

Pull down the status bar to open the shortcuts window which contains brightness adjustment, Wi-Fi, no SIM card, do not disturb, landscape, bluetooth, airplane mode, physical button and invert colors, and system settings entrance.

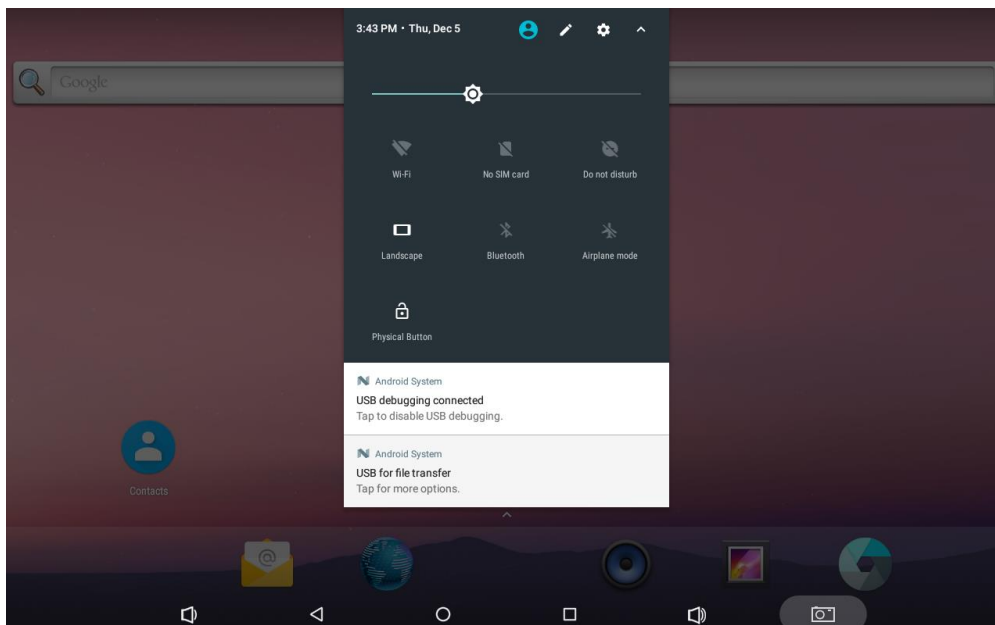

Applications

Tap Λ above the app shortcuts on the home screen to view the App list.

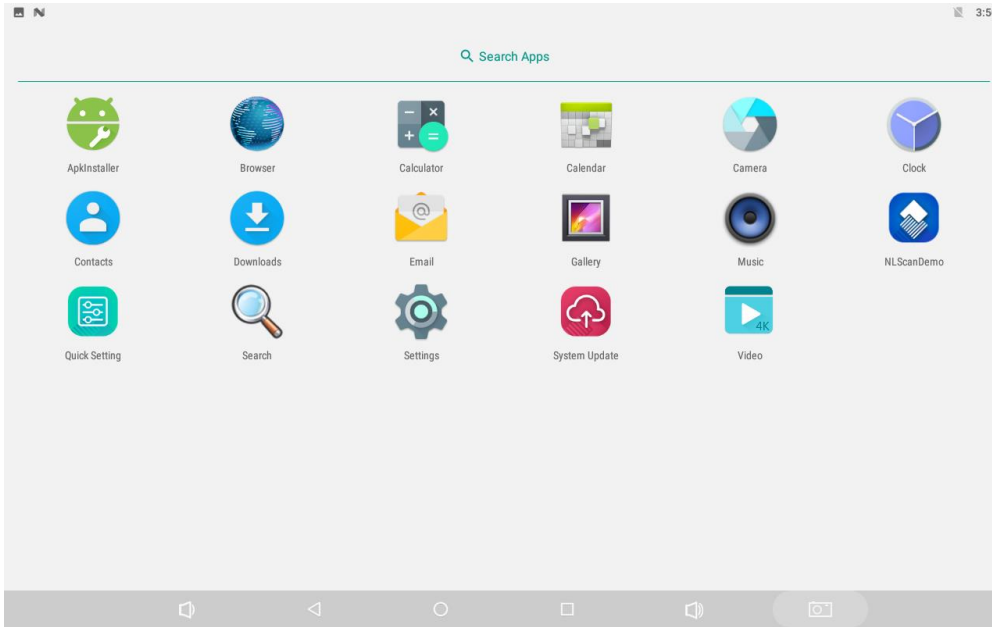

The installed applications will be shown here and you can open an app by tapping its icon. To find an app easily, you can create a shortcut by long-taping on the icon and dragging it into the home screen.

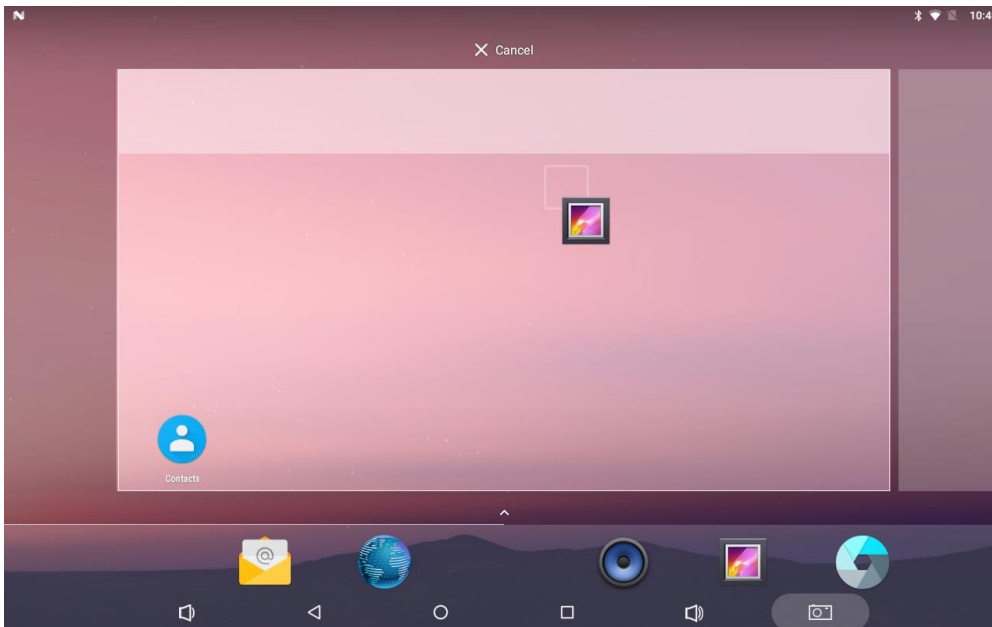

Language & Input Method

In the App list, tap “**Settings**”  to open the system settings app, and select “**Language & input**”.

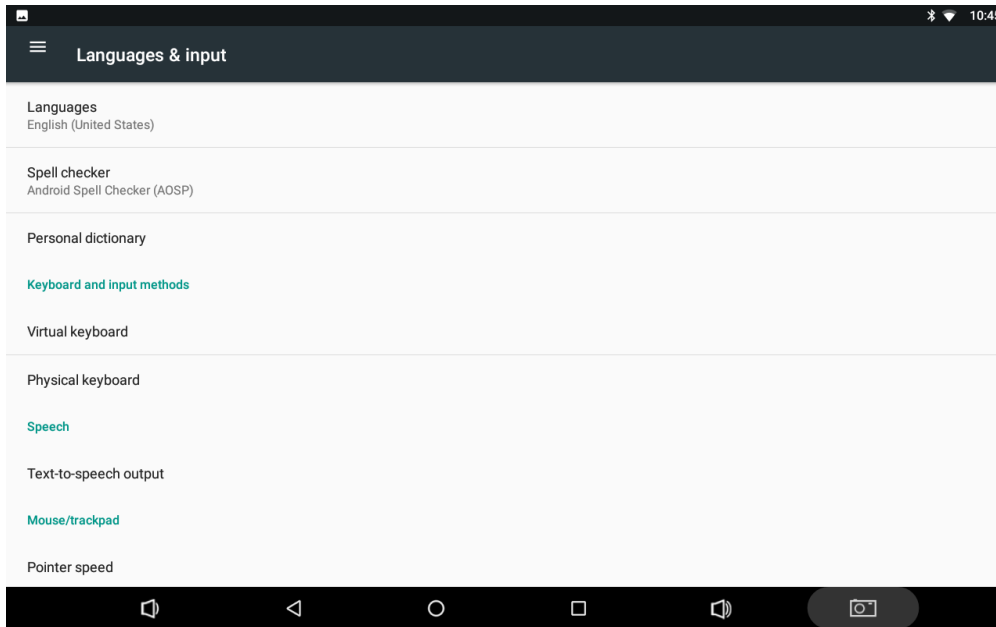

Change language: Tap “**Language**” then “**Add a language**”, and then you can change the system language according to your preference.

Enable an input method: Tap “**Virtual keyboard**” then “**Manage keyboards**”, and then enable the desired input method.

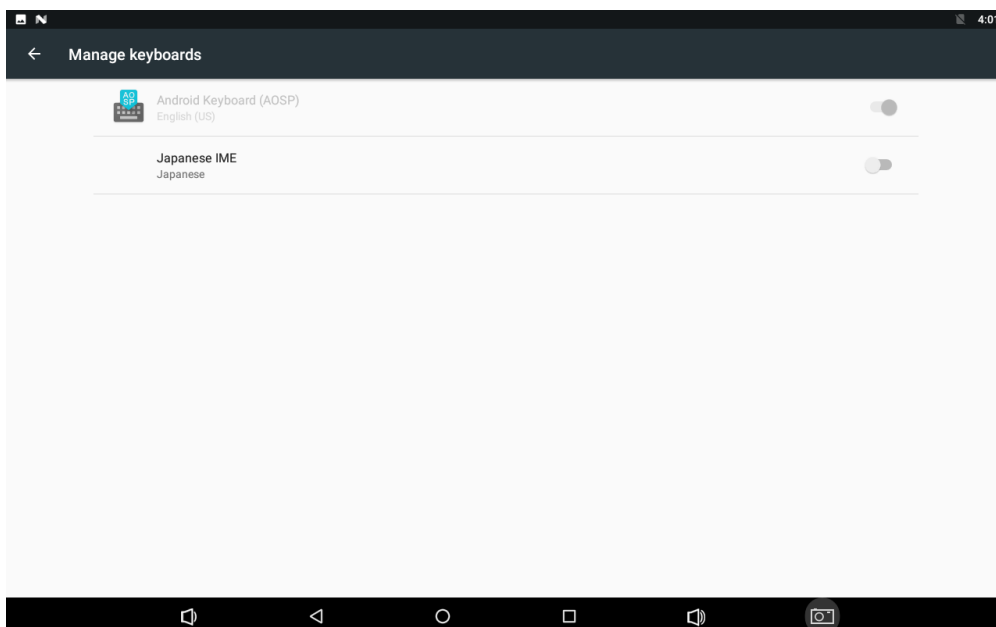

Date & Time

In the App list, tap **“Settings”**  to open the system settings app, and select **“Date & time”**.

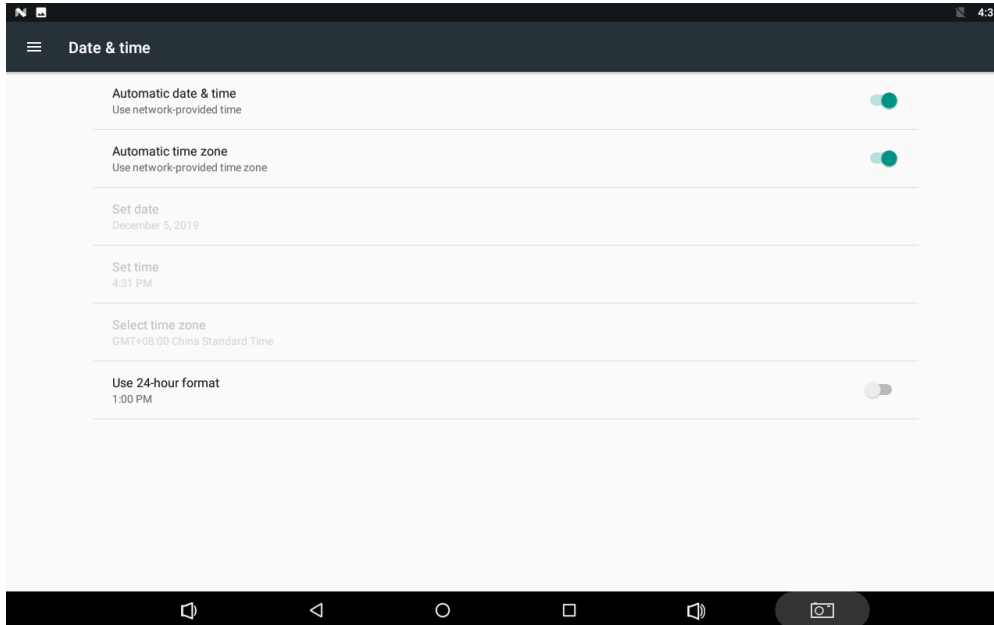

If the **“Automatic date & time”** option is enabled, system date and time will be synchronized automatically with network time when you connect your device to a Wi-Fi network.

To set the time manually, you need to disable **“Automatic date & time”** & **Automatic time zone**.

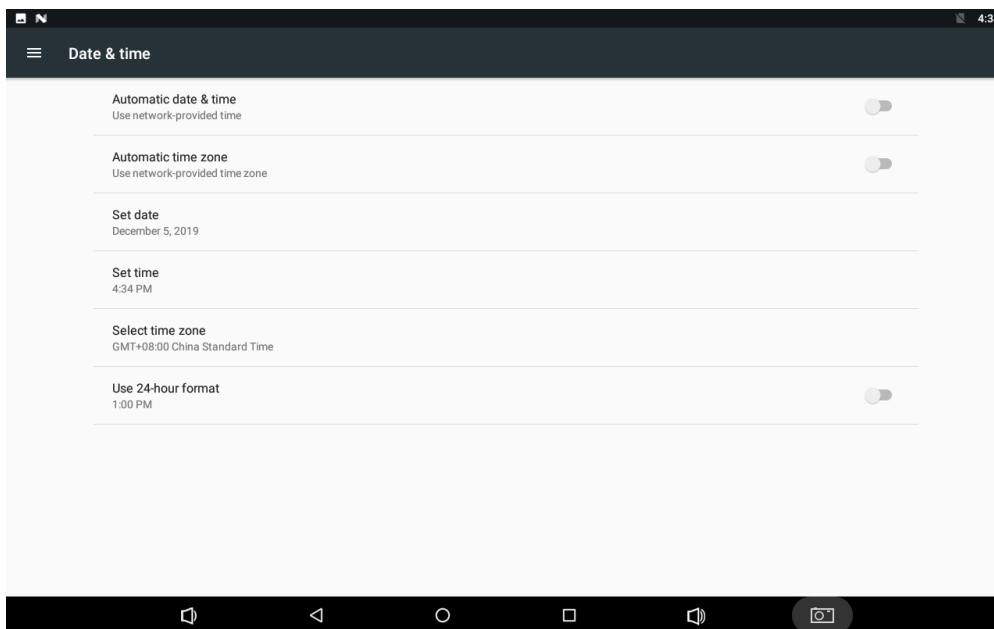

Besides, you can also set time zone and time format as per your needs.

Volume

On the system bar, click the **Volume-** icon  to decrease the system volume, and click the

Volume+ icon  to increase the system volume.

Or you can press the **Vol+** / **Vol-** keys (#5 in Device Instruction) on the top of the device to adjust the volume.

Brightness

In the App list, tap **“Settings”**  to open the system settings app, and select **“Display”**. Tap **“Brightness level”** and then move the brightness slider to the left to decrease the brightness and right to increase it.

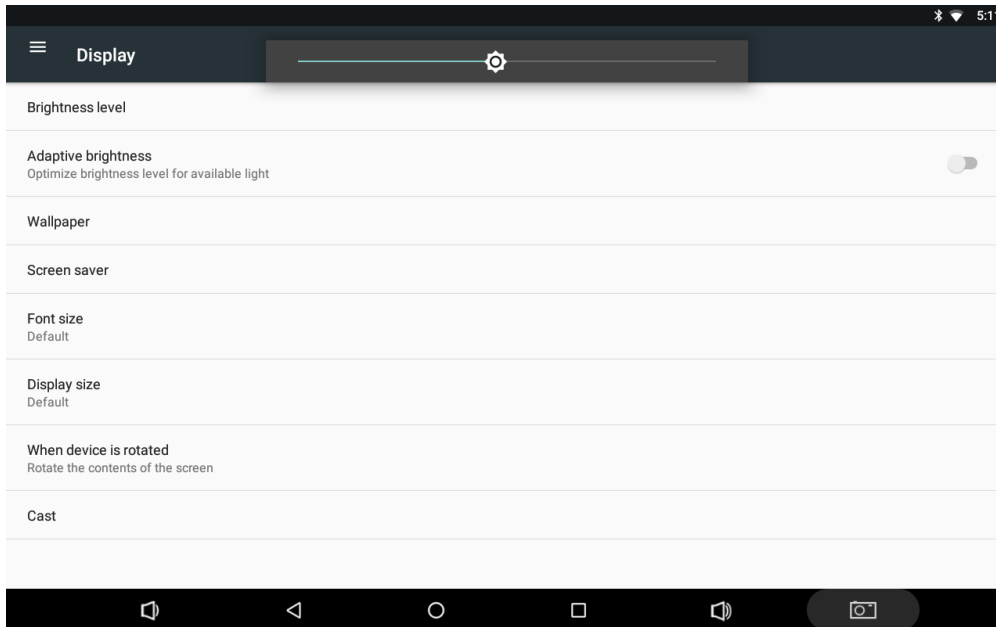

If you want the brightness to be adjusted automatically based on ambient lighting, enable the **“Adaptive brightness”** option.

Schedule Power On/Off

This function is used to power the device on and off automatically at a specific time each day. In the App list, tap “**Settings**”



to open the system settings app, and select “**Time Screen**”.

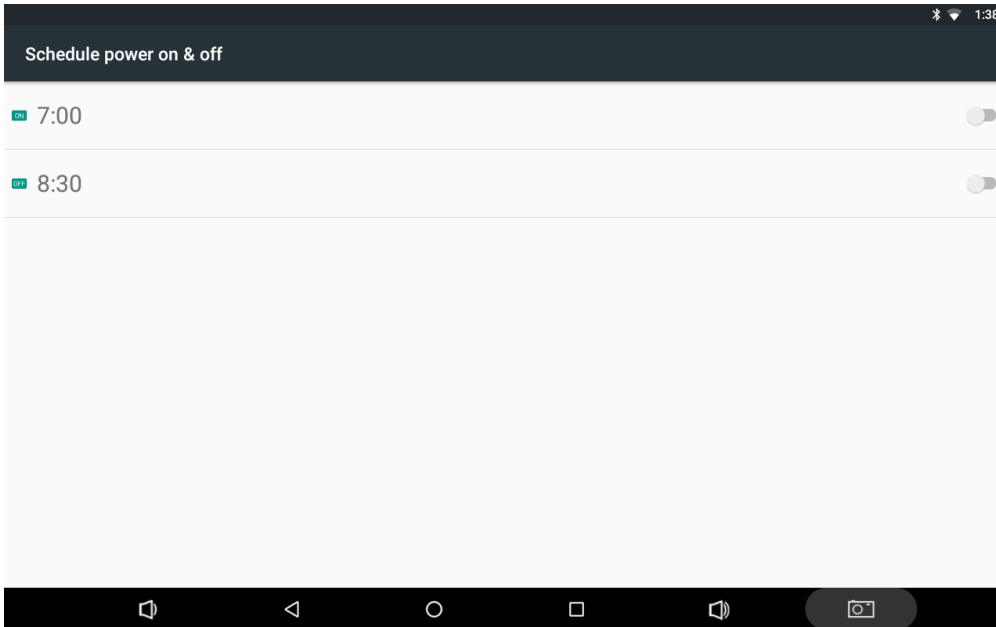

The top row is for power on clock, and the following row is for power off clock. To enter the power on/off clock settings, tap the corresponding row.

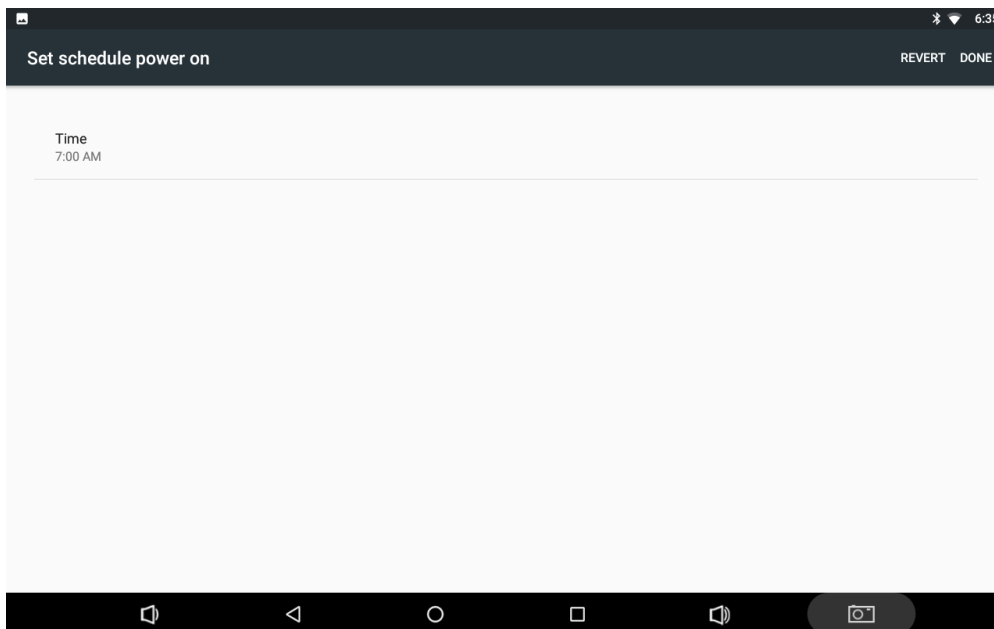

Tap **Time**. Then set the time and tap **OK**.

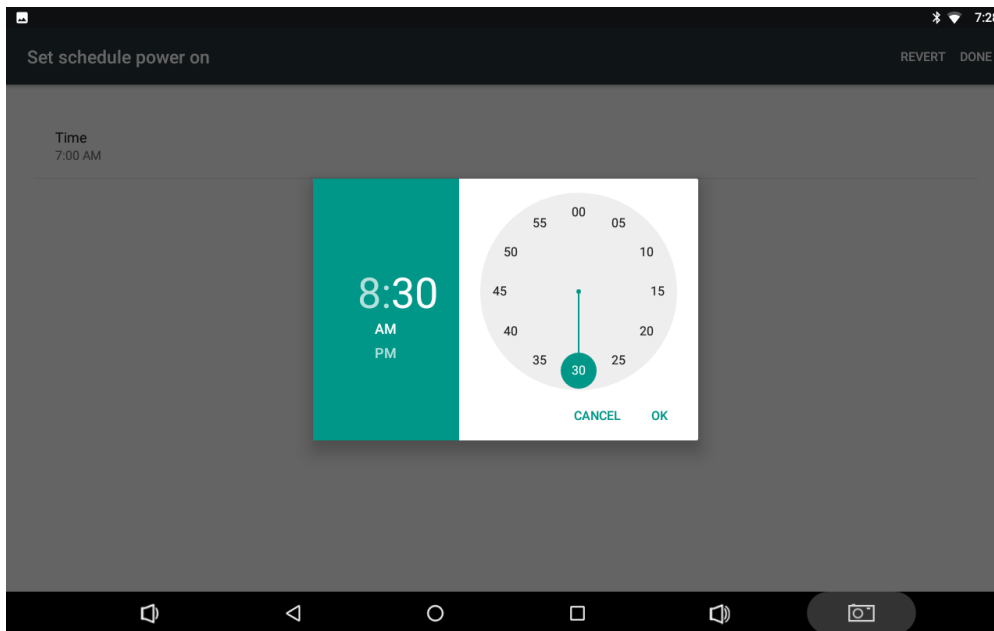

Tap **DONE** at the upper-right corner of the screen to save the setting.

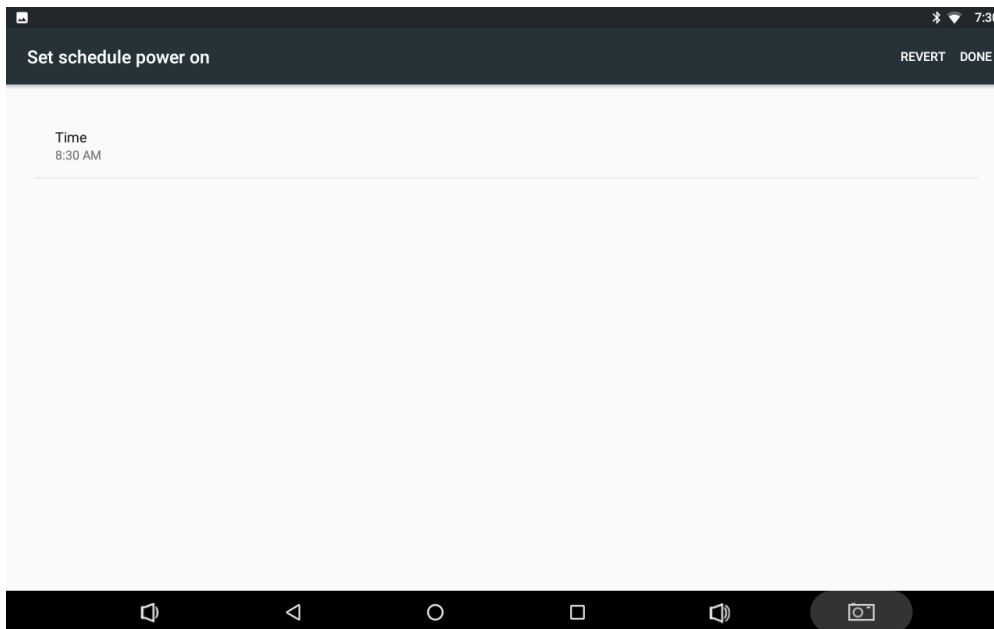

Wi-Fi

Join a Wi-Fi network: In App list, tap **“Settings”**  to open system settings app, and select **“Wi-Fi”**. Turn Wi-Fi on to find available Wi-Fi networks. Select a network and enter the password, then tap **“CONNECT”**.

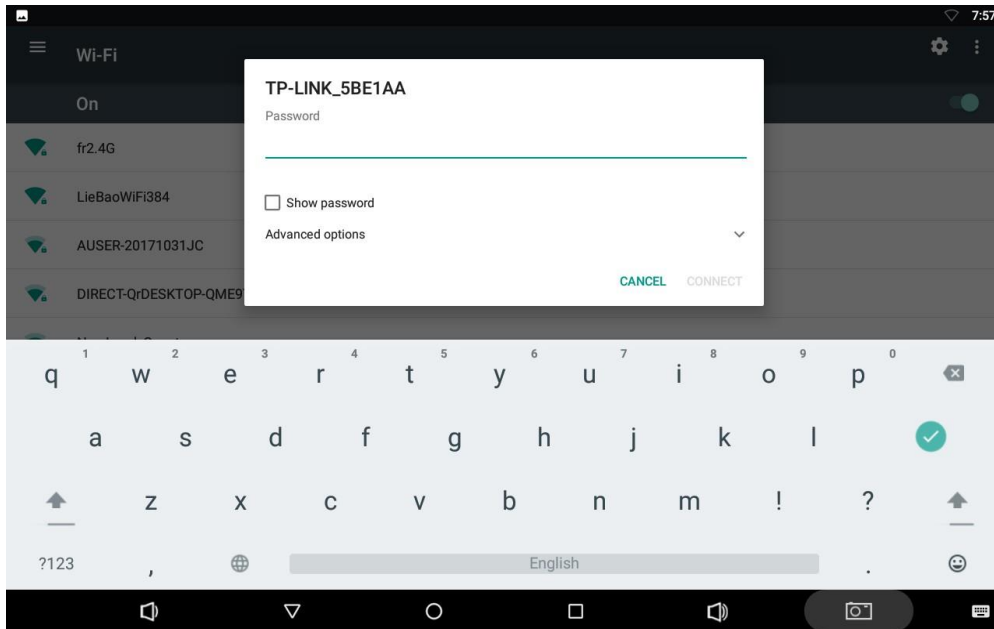

Ethernet

Be sure to turn off Wi-Fi if you want to connect your device to the Internet through Ethernet. Plug the Ethernet cable into your device's Ethernet port (#13 in Device Instruction).

In the App list, tap **"Settings"**  to open the system settings app, and select **"More"**. Tap **"Ethernet"**.

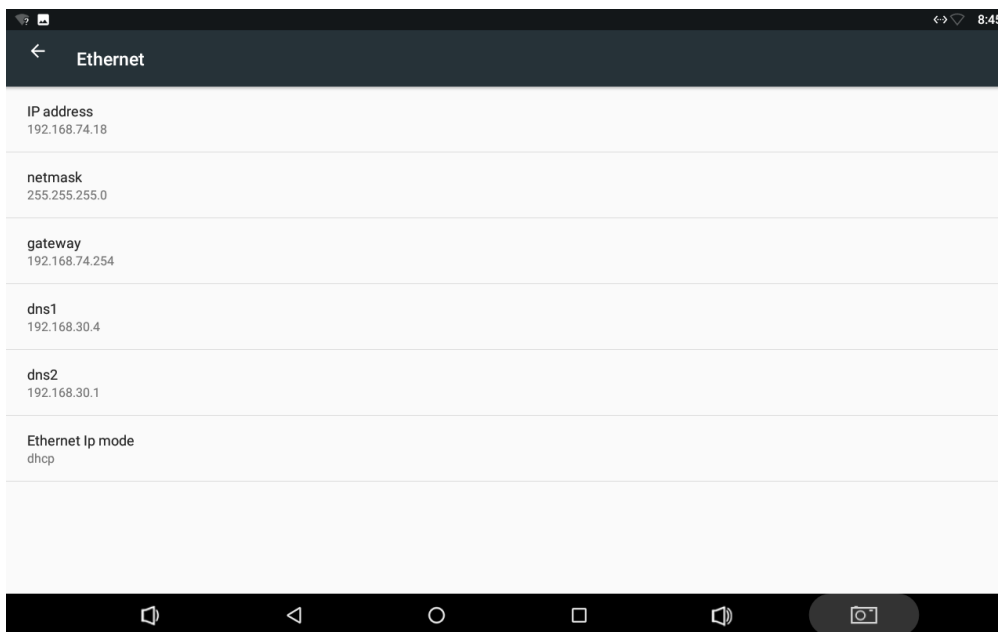

If you want to specify a static IP address for your device, tap **"Ethernet Ip mode"** then **"static"**, and enter the IP address, gateway, netmask and DNS server. Tap **"CONNECT"**.

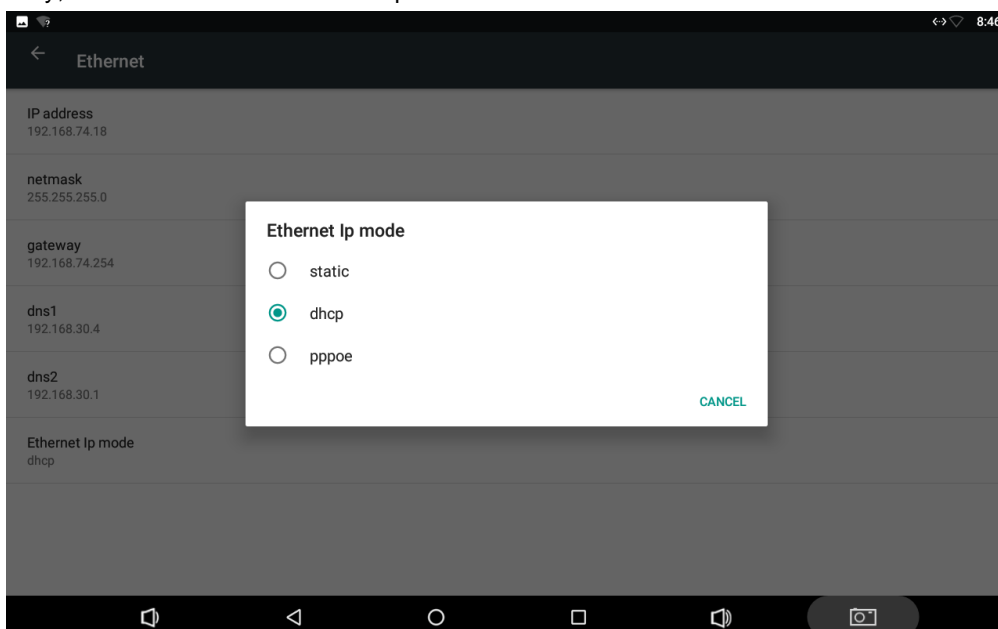

Bluetooth

You can set up a Bluetooth connection between the device and other Bluetooth devices, such as PC, mobile phone. Note that Bluetooth connection works better if there are no obstacles between them.

Pair your device to a Bluetooth device: In the App list, tap **“Settings”**  to open the system settings app, and select **“Bluetooth”**. Turn Bluetooth on to search for available Bluetooth devices. Select the desired device from the search results and then tap **“PAIR”**.

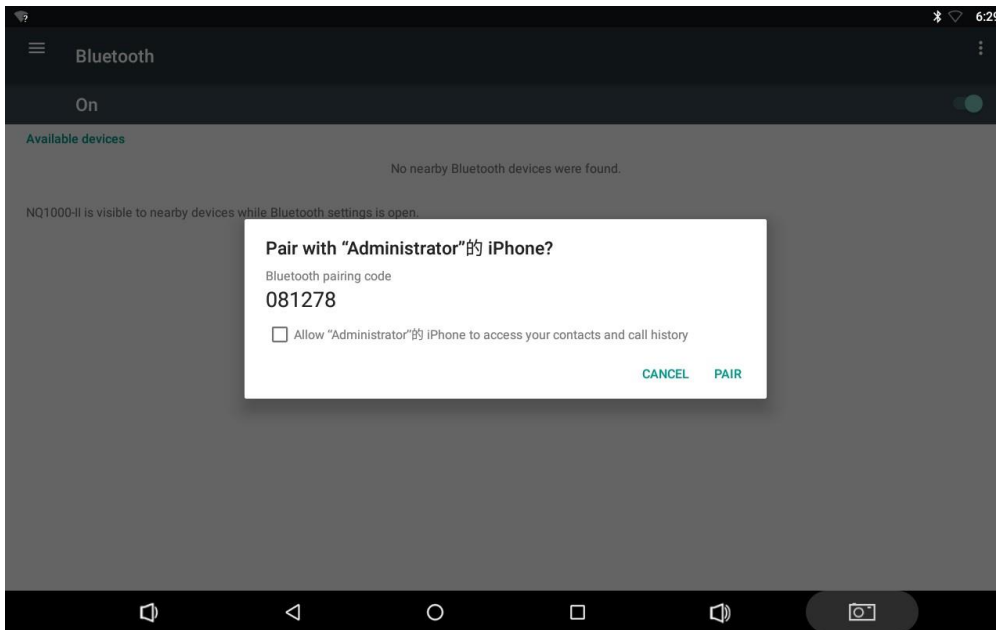

After pairing, the paired device will be moved to the “Paired Devices” list.

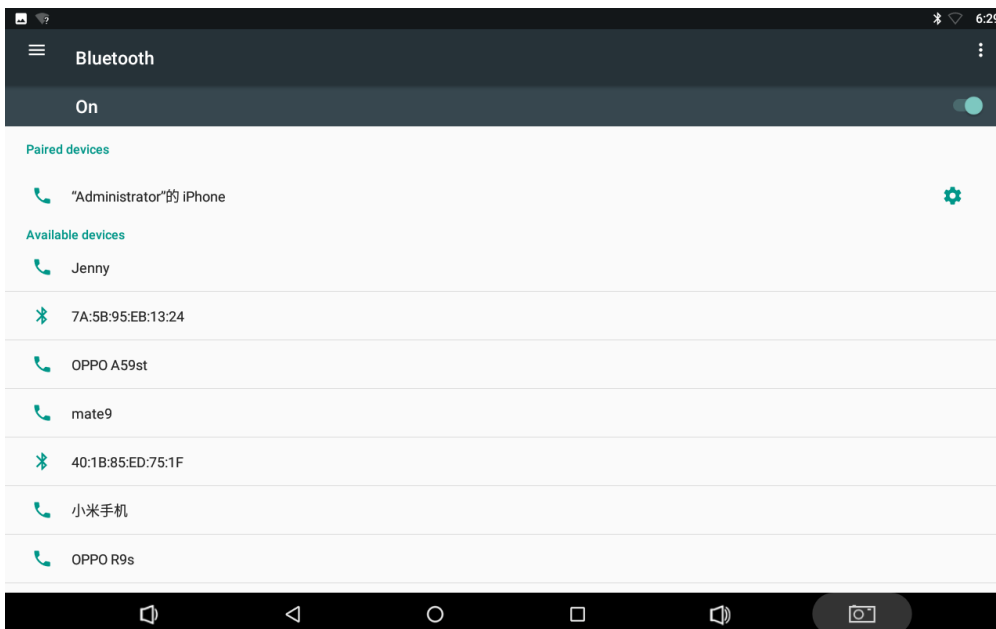

Virtual Keyboard

The device provides a virtual keyboard for typing. You can use it as a real one.

When you tap a text input field, the virtual keyboard will appear at the bottom of the screen. To close the virtual keyboard, you can tap  in the system bar at the bottom of the screen.

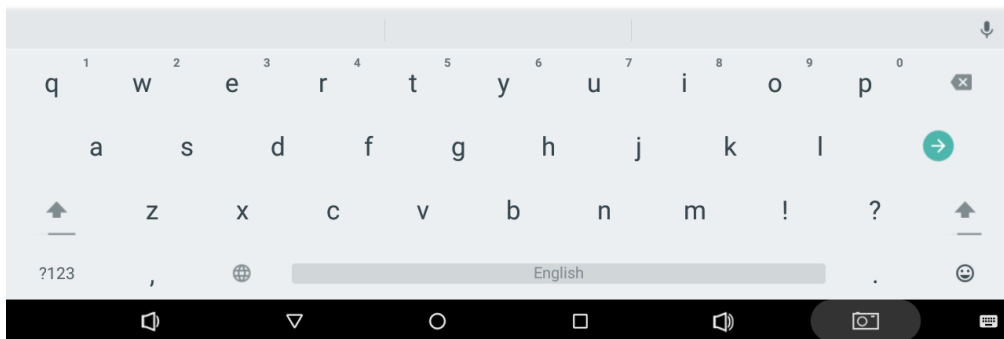

Change keyboard: Tap  in the lower-right corner of the screen, and then select the desired keyboard from the pop-up window.

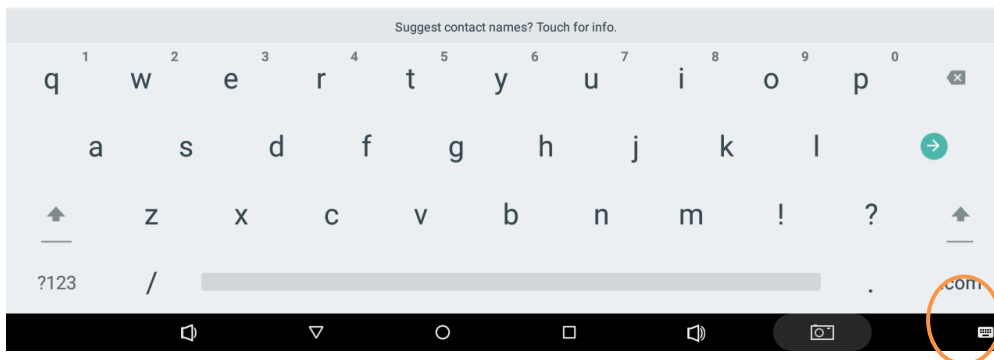
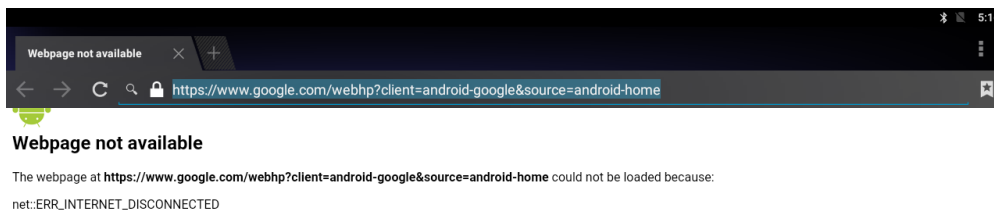

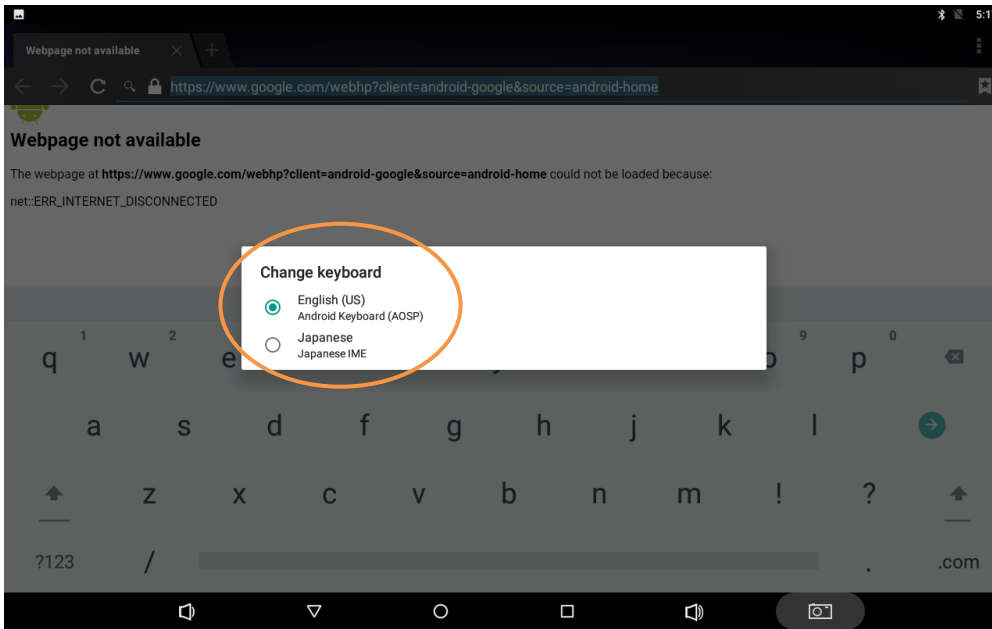



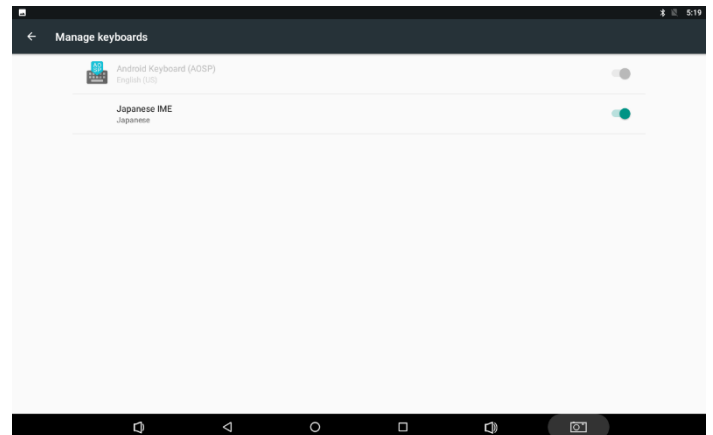
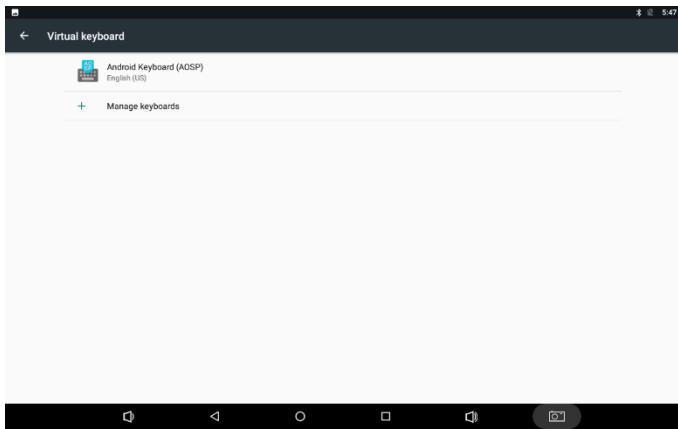

If the keyboard icon  is not present in the system bar, go to **Settings > Languages & input > Virtual keyboard > Manage keyboards** > enable the input method(s) you want to use.

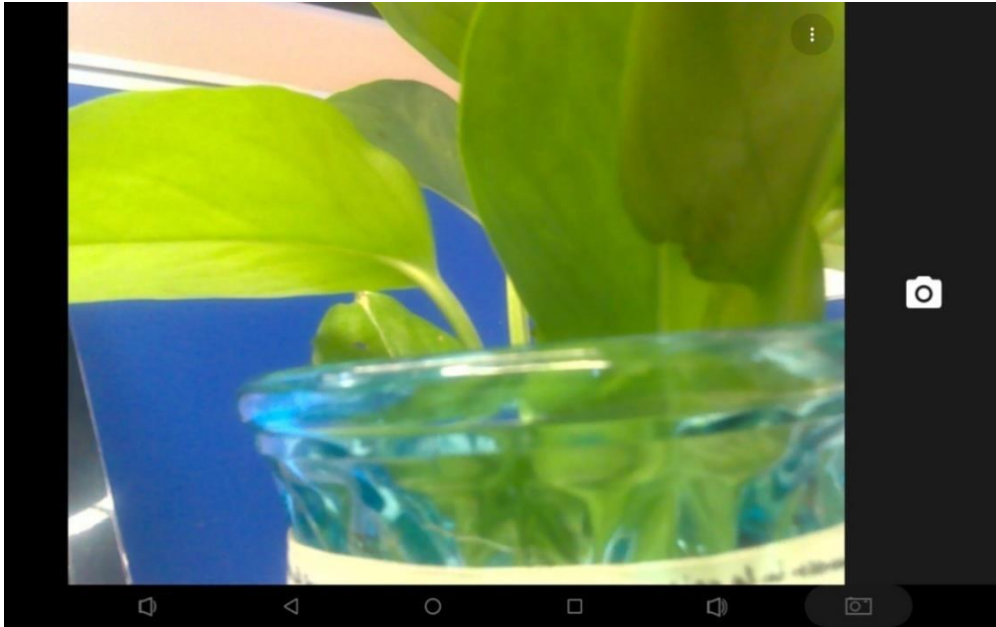

Take Photos

In the App list, tap  to launch the Camera app. Tap  take a photo.



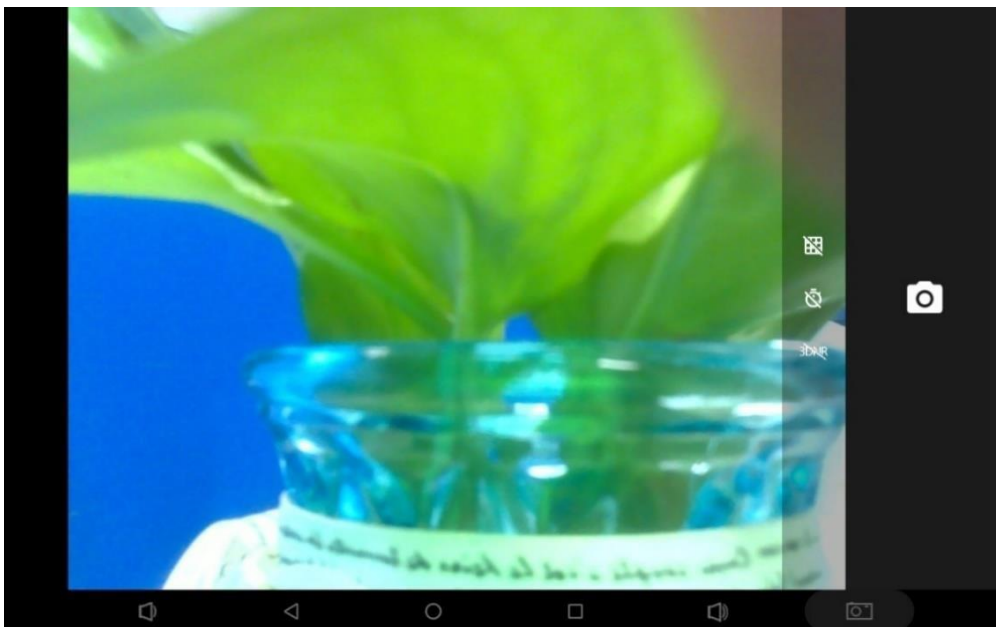

Tap  to open detail settings. From top to bottom in the picture are: grid lines, timer and 3DNR.



Surf Online

In the App list, tap  to launch the Browser app.

When connecting the device to a network, you can visit websites, play online media or download files via the browser.

In a browser window, enter a URL into the address bar and tap  on the virtual keyboard to open the URL. You can also tap  to add new tabs to open multiple webpages simultaneously in one window.

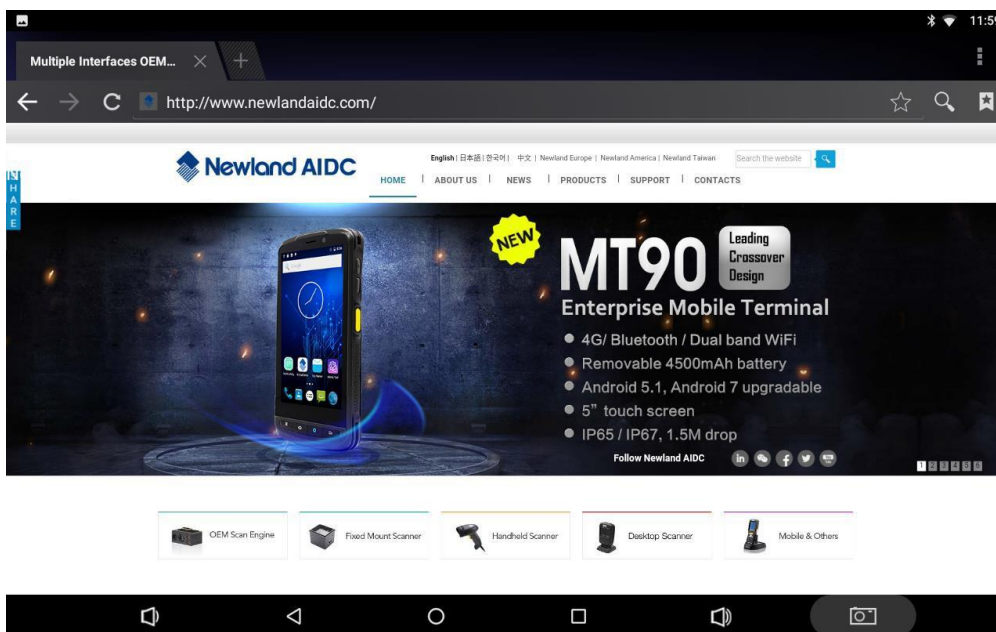

Play Media

With the provided apps, you can play your media files on your storage, such as pictures, music, and videos.



Picture Player:

Support JPG, BMP, GIF, PNG



Music Player:

Support MP2, WMA, WAV, AAC, OGG, ASF.



Video Player:

Support MKV, TS, FLV, AVI, VOB, MPG, DAT, ASF, RM, MOV, 3GP, MP4, WMV

Install & Uninstall Apps

Install Apps

Before installing an app, please download the app (.apk) to using the browser, or copy a downloaded app (.apk) to the device from your computer.

Then you can open the ApkInstaller app  in the App list to install the downloaded app. Tap **"Install"** button.

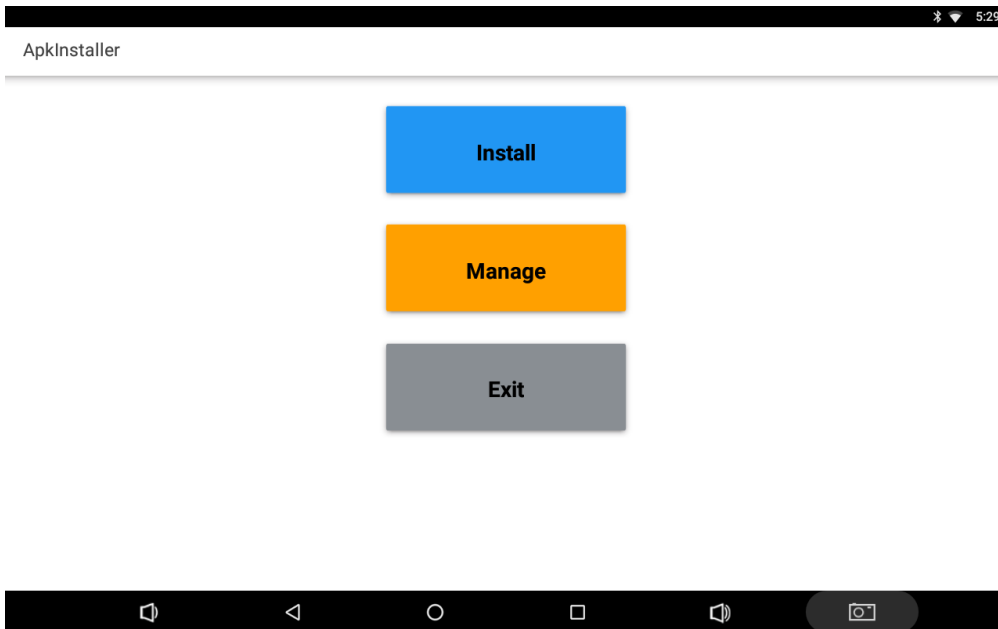

Open the folder containing the apk file.

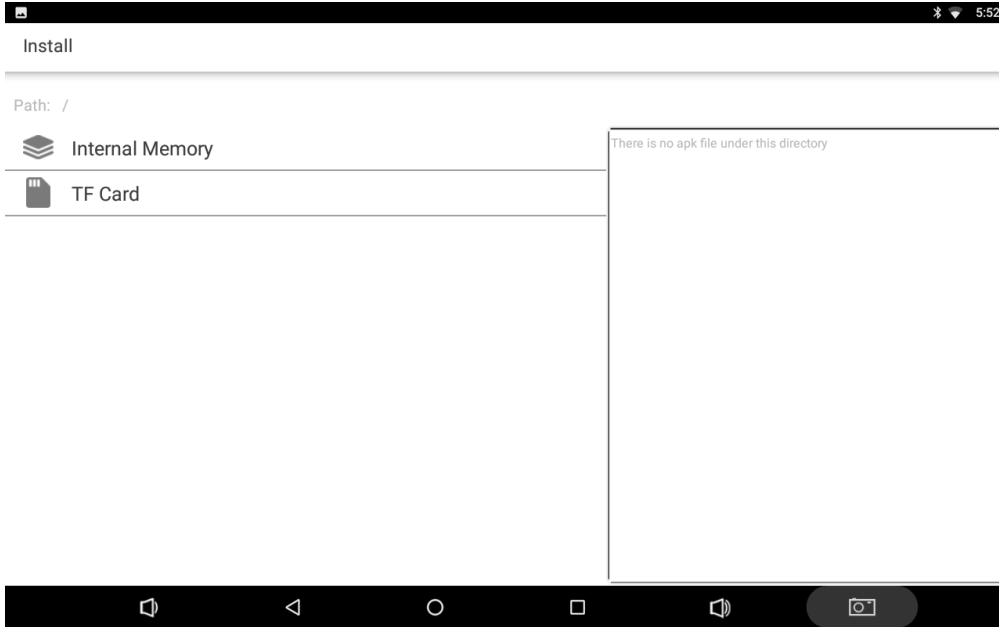

Tap the apk you want to install.

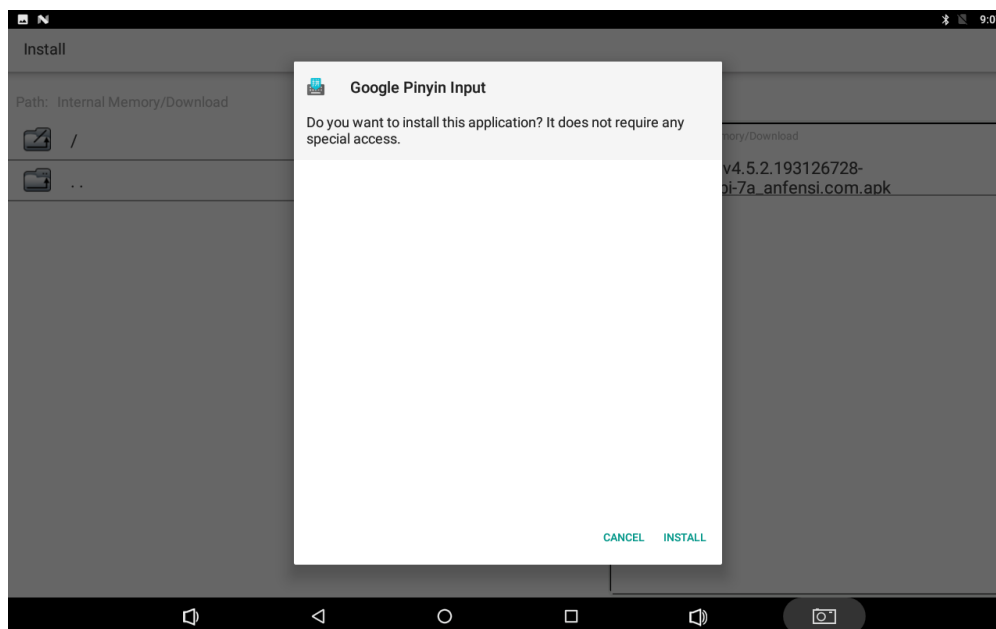

Tap **“INSTALL”** and then wait for the installation to complete.

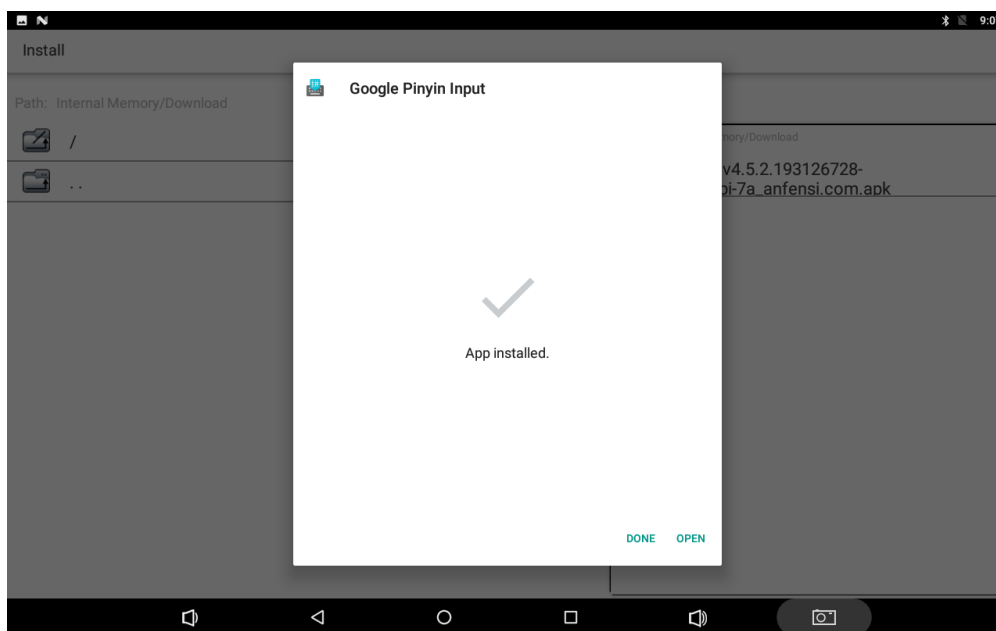

You can also download an android app market, and install the apps via the market.

If receiving the “For security, your tablet is set to block installation of apps obtained from unknown sources” message when installing an app, tap “**SETTINGS**” then go to “**Security**”, and enable the “**Unknown sources**” option, and then reinstall the app.

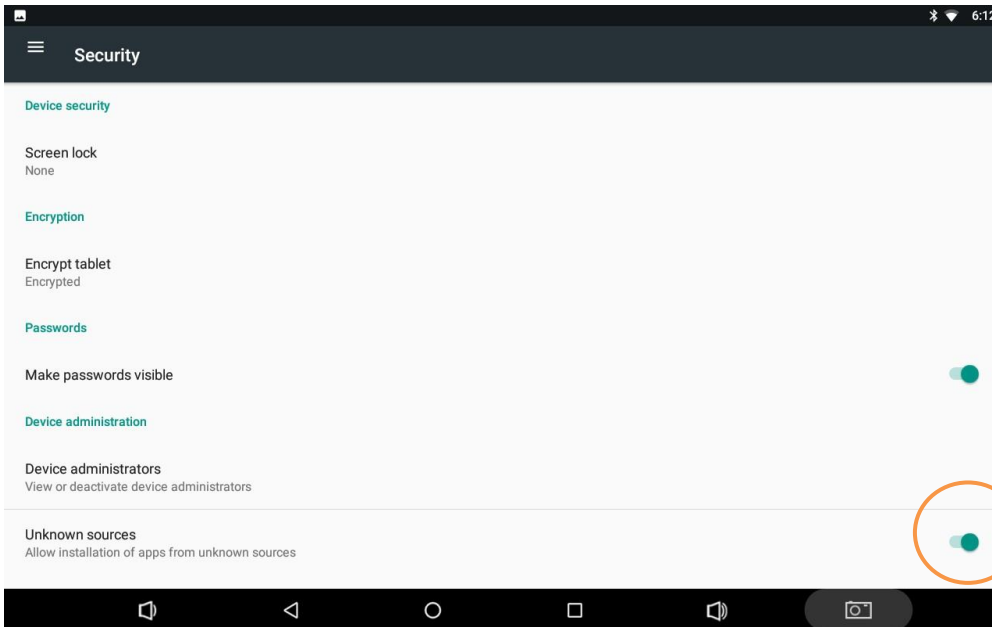
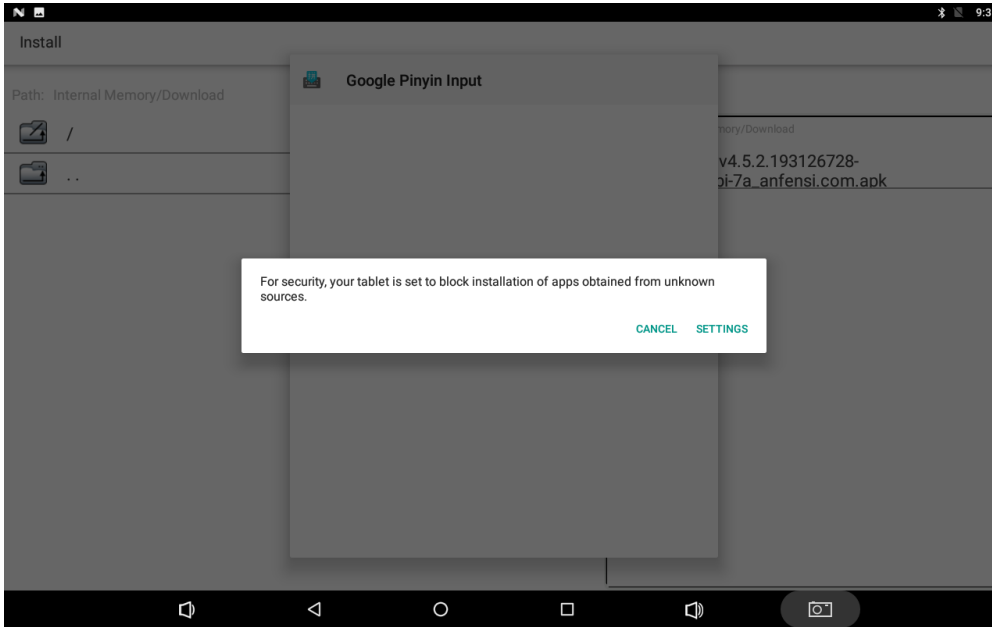

Uninstall Apps

To uninstall an app, Open the Settings app  in the App list, and select “Apps”.

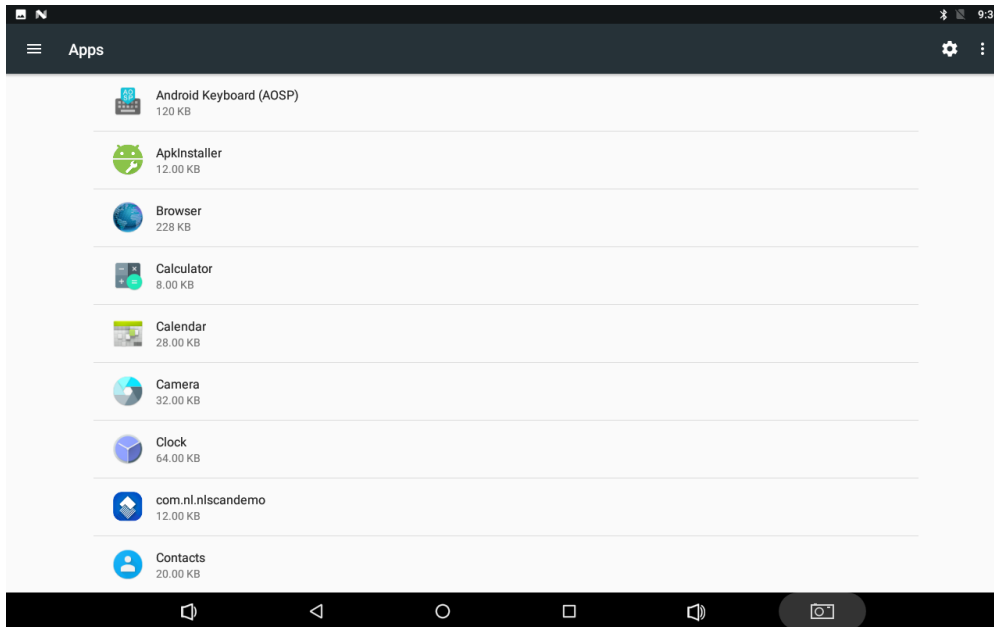

Tap the app you want to remove.

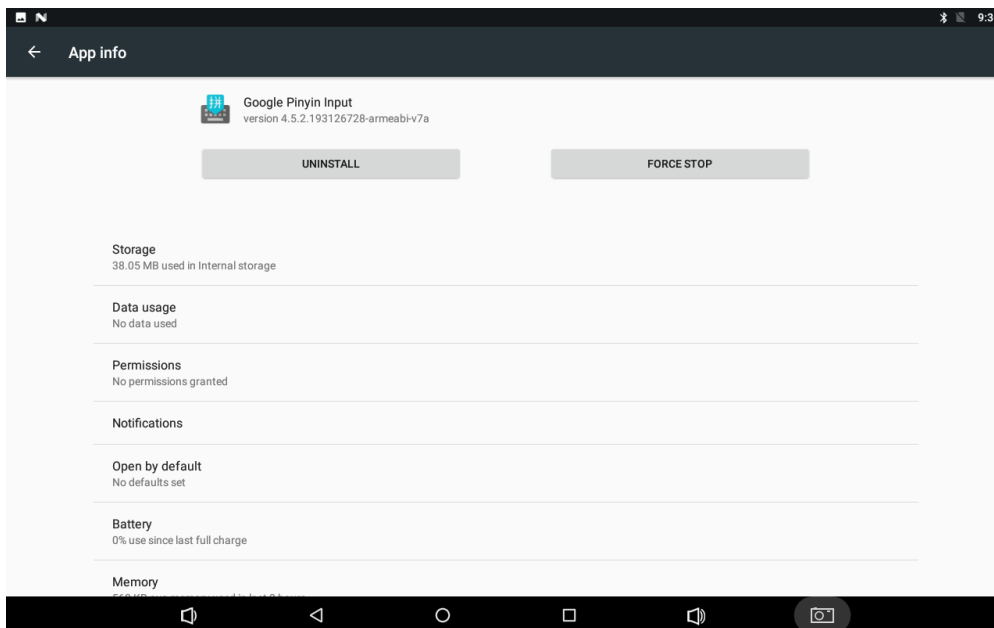

Tap the “**UNINSTALL**” button then “**OK**”, and then wait for the uninstallation to complete.

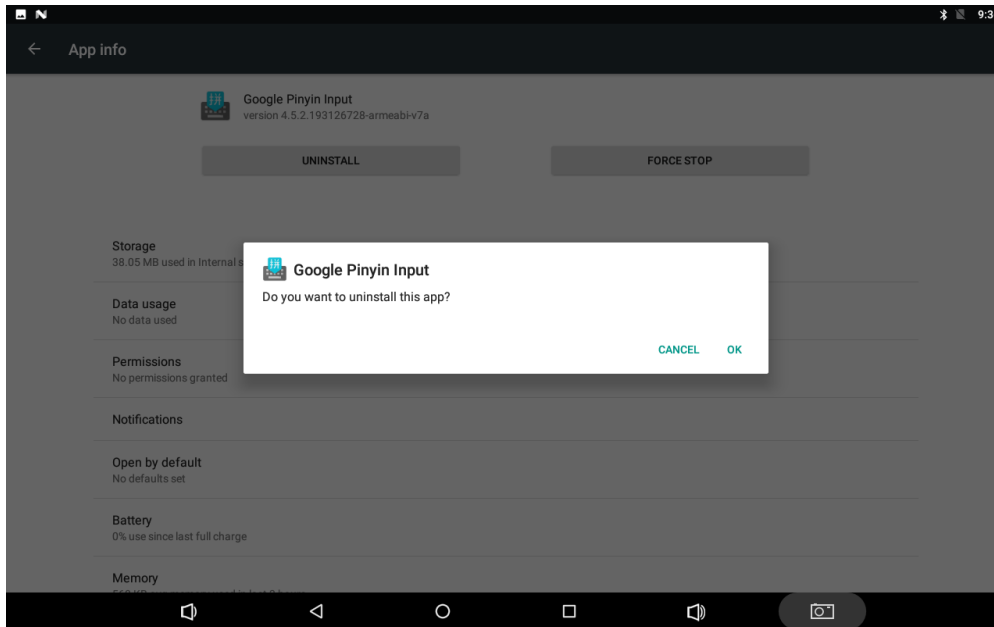

Reset to Factory Default

Please make sure to back up the important data before resetting the device.

In the App list, tap **“Settings”**  to open the system settings app, and select **“Backup & reset”**.

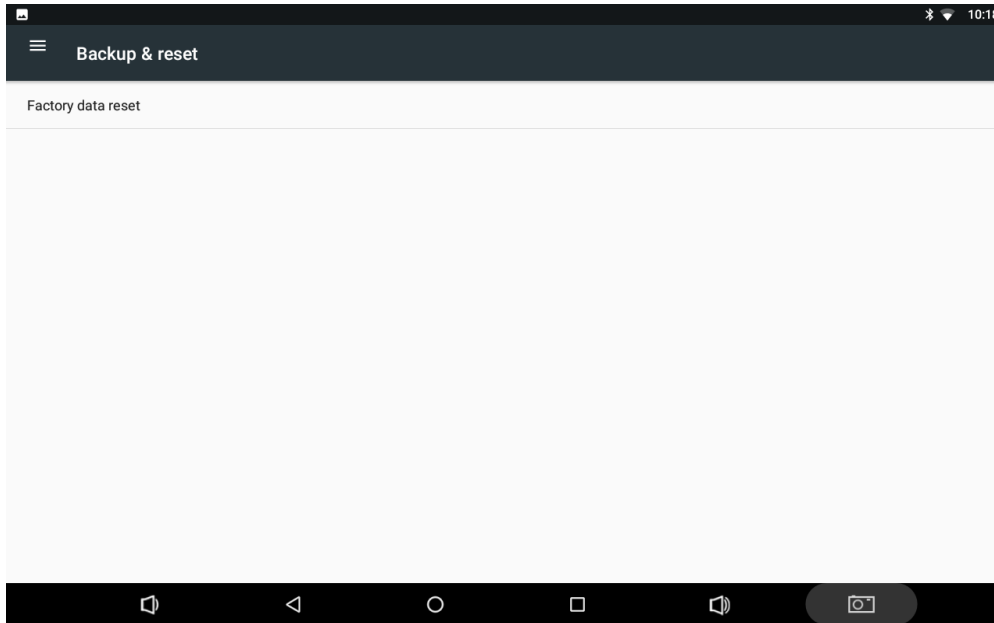

Tap **“Factory data reset”**.

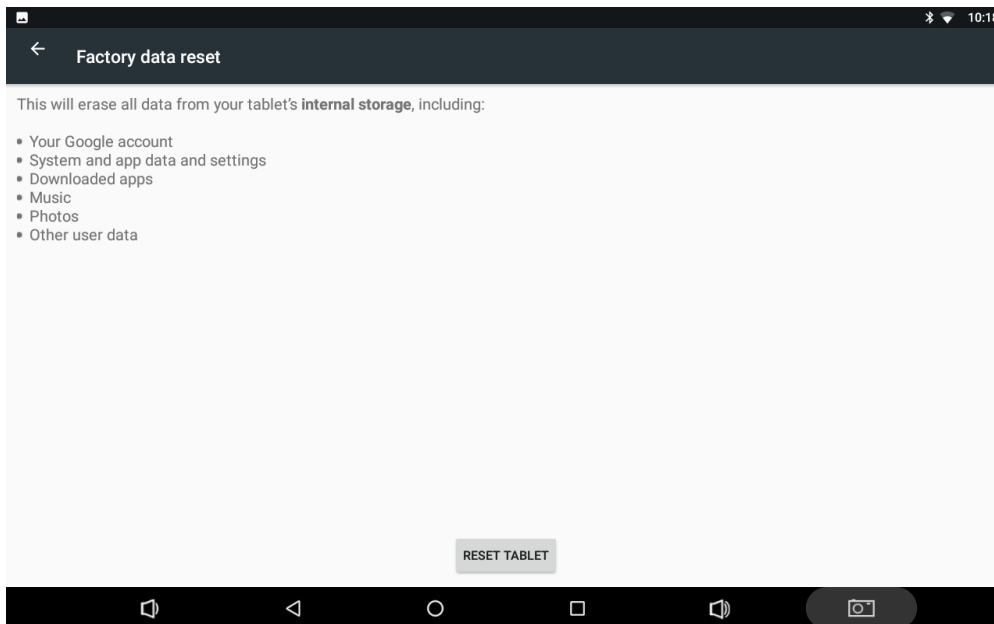

Tap the “**RESET TABLET**” button.

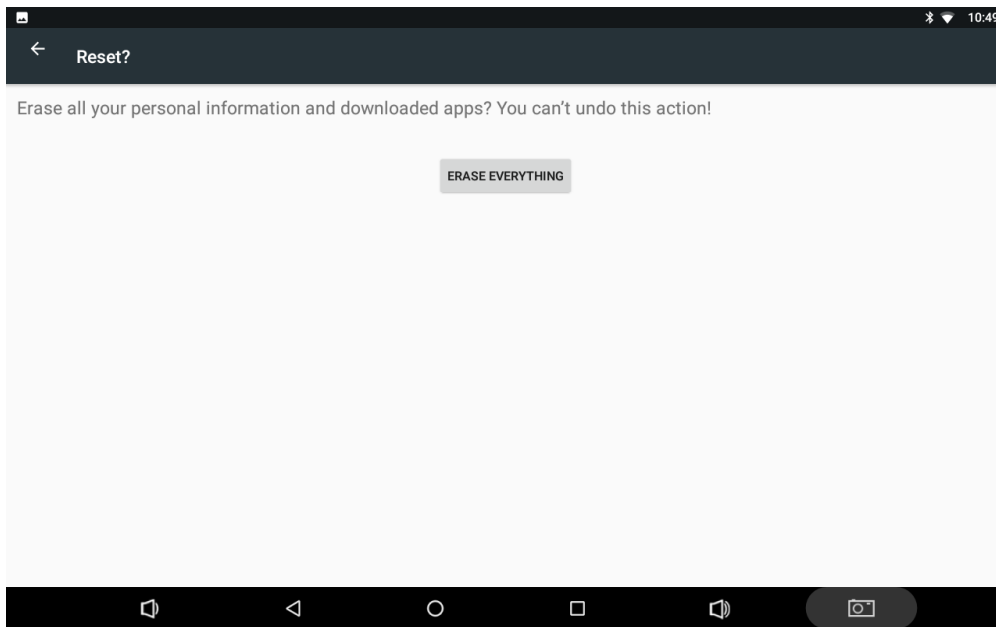

Tap the “**ERASE EVERYTHING**” button. Then the device will reboot and reset to factory default.

Chapter 4 Important Safety and Handling Information

- ✓ Do not put the product in high temperature, humid or dusty environment.
- ✓ Do not drop, crash or break down this product.
- ✓ Do not power off the device when it's formatting or upgrading, otherwise it will cause operation system error.
- ✓ This product is IP54 certified in waterproof and dustproof on front panel (only).
- ✓ Use only approved add-on enhancements.



Newland EMEA HQ

+31 (0) 345 87 00 33
info@newland-id.com
newland-id.com

D-A-CH

0049 (0) 6182 82916-16
info@newland-id.de

United Kingdom

+44 (0) 7771 631387
sales@newland-id.co.uk

France

+39 (0) 345 8804096
france@newland-id.com

Russia

+31 (0) 345 87 00 33
russia@newland-id.com

Benelux

+31 (0) 345 87 00 33
benelux@newland-id.com

South Africa

Gauteng: +27 (0) 11 553 8010
Cape Town: +27 (0) 21 9140819
info@newland-id.co.za

Ibérica

+34 (0) 93 303 74 66
info@newland-id.es

Middle East

+39 (0) 345 8804096
middleeast@newland-id.com

Italy

+39 (0) 342 0562227
italy@newland-id.com

Turkey

+90 (0) 544 538 40 49
turkey@newland-id.com

Nordic & Baltic

+46 (0) 70 88 47 767
nordic@newland-id.com