

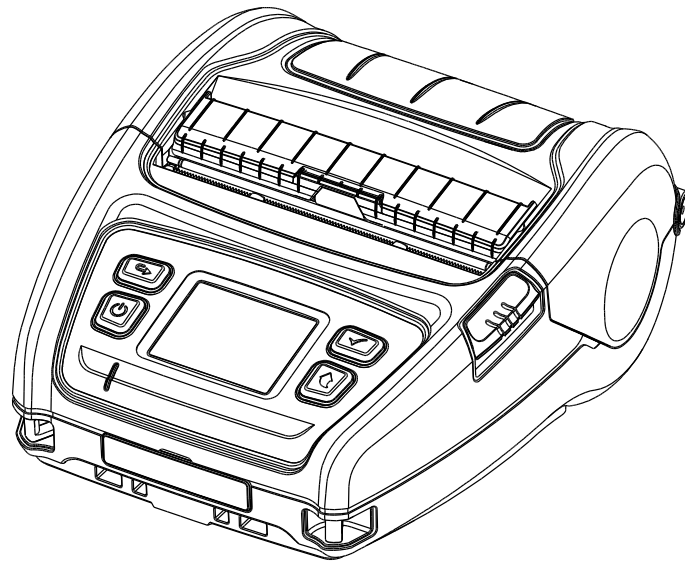

User's Manual

PV4

BARCODE PRINTER
Rev. 1.00



Introduction

The PV4 is a 4-inch thermal mobile label printer which simultaneously connects with Bluetooth and WLAN. Ideal for smart mobility labelling due to its compact, lightweight design with an easy-to-open peeler and LCD.

※ **The main features of the printer are as follows**



- | |
|---|
| <ol style="list-style-type: none">1. 4-inch Mobile Label Printer2. Maximum 127 mm/s (5ips) printing speed.3. Compact and light design 158 x 186 x 82 mm (6.23 x 7.33 x 3.23 inch) (W x D x H)4. Peeler5. Paper guide (paper width : 50 ~ 112 mm)6. Wireless connectivity (Bluetooth V5.0(Classic / LE), Wireless LAN 802.11 a/b/g/n) |
|---|

It is advisable to read the contents of this manual carefully before using the printer for the first time.

※ **Use only authorized supplies that can be trusted!**

We are not responsible for quality and service for damage caused by the use of unauthorized supplies (or recycled ones).

Safety Information

 Warning	Warnings must be heeded carefully in order to prevent serious physical harm.
 Caution	Cautions must be heeded in order to prevent minor injuries, equipment damage, or data loss.

Symbol Information





	DC (Direct current)
	Warning, Caution 2
	USB
	Ethernet

Table of Contents

- 1. Content Confirmation12**
- 2. Product Part Names12**
- 3. Installation & Usage14**
 - 3-1 Battery Installation.....14
 - 3-2 Battery Charging14
 - 3-2-1 Using AC/DC Adaptor.....14
 - 3-2-2 Using 1CH Battery Charger (Optional).....15
 - 3-2-3 Using 4CH Battery Charger (Optional).....15
 - 3-3 Paper Installation17
 - 3-4 Using Peeler.....18
 - 3-5 Using Belt Strap19
 - 3-6 Using Fan-Fold Paper20
 - 3-7 Using Control Panel21
 - 3-9 Recommended Papers22
- 4. Self-Test23**
- 5. LCD Menu.....25**
 - 6-1 Bluetooth, Wireless LAN Connection28
 - 6-2 Interface Cable Connection.....29
 - 6-3 Fixed Interface Cable Connection30
- 7. Printer Cleaning.....31**
- 8. Appendix32**
 - 8-1 Specifications32
 - 8-2 Label Types.....33

Manual Information

This user's manual contains basic information for product usage as well as for emergency measures that may be required.

※ The following separate manuals provide more detailed content on various technological issues and areas.

1. Software Manual

This manual provides information for development.
Please refer to each manual for more information.

- Windows Driver Manual
- OPOS Driver Manual
- Linux CUPS Driver Manual
- MAC CUPS Driver Manual
- Virtual Com for USB Driver Manual
- iOS Label Printer SDK Manual
- Android Label Printer SDK Manual
- Windows CE SDK Manual
- Windows Label SDK Manual
- Linux Label SDK Manual
- Xamarin SDK Manual
- Unified Label Utility-II Manual
- Net Configuration Tool Manual
- mPrint Server Manual

2. Bluetooth, Wireless LAN Connection Manual

- Bluetooth Connection Manual
 - This manual describes how to connect terminals (PDAs, PCs, etc.) with Bluetooth functionality.
- Wireless LAN Connection Manual
 - This manual describes how to connect wireless LAN in infrastructure or Soft AP

3. Commands Manual

This manual provides information on the protocol and functions of the control commands that can be used with this product.

4. Code Pages Manual

The following pages show the character code tables. To find the character corresponding to a hexadecimal number, count across the top of the table for the left digit and count down the left column of the table for the right digit.

5. SLCS(Programming) Manual

In this chapter, the basic concept of SLCS and some information necessary for the programmer to use SLCS will be explained. Please read this part before starting programming for efficient and ease of use of SATO BARCODE PRINTERS.

6. Paper Specification

This manual contains paper specifications needed to use barcode printer.

Safety Precautions

In using the present equipment, please keep the following safety regulations in order to prevent any hazard or material damage.



WARNING

Violating following instructions can cause serious injury or death.

Do not plug several products into one multi-outlet.

- This can provoke over-heating and a fire.
- If the plug is wet, or dirty, wipe it before using.
- If the plug does not fit perfectly in the outlet, do not plug in.
- Be sure to use only standardized multi-outlets.

PROHIBIT

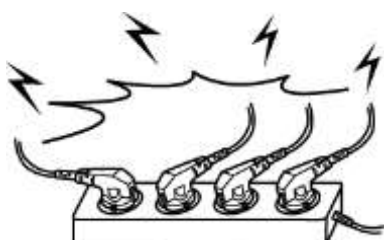

You must use only the supplied adaptor.

- It is dangerous to use other adaptors.

PROHIBIT



Do not pull the cable to unplug.

- This can damage the cable, could cause fire or a breakdown of the printer.

PROHIBIT

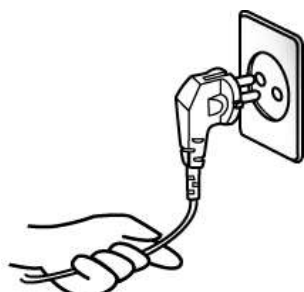

Keep the plastic bag out of children's reach.

- If not, a child may put the bag on their head.

PROHIBIT



Do not plug in or unplug with wet hands.

- You could be electrocuted.

PROHIBIT



Do not bend the cable by force or leave it under any heavy object.

- A damaged cable can cause a fire.

PROHIBIT

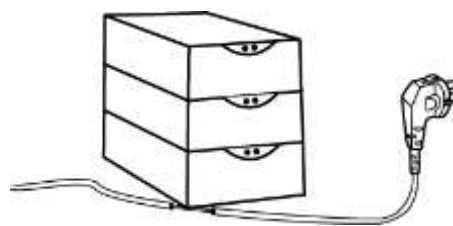



CAUTION

Violating following instructions can cause an injury or damage the appliance.

If you observe a strange smoke, odour or noise from the printer, unplug it before taking following measures.

- Switch off the printer and unplug the set from the mains.
- After the disappearance of the smoke, call your dealer to repair it.

TO UNPLUG



Keep the desiccant out of children's reach.

- If not, they may eat it.

PROHIBIT



Install the printer on a stable surface.

- If the printer falls down, it can be broken and you can hurt yourself.

PROHIBIT

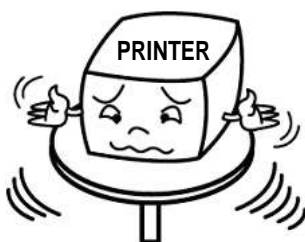

Use only approved accessories and do not try to disassemble, repair or remodel it for yourself.

- Call your dealer when you need these services.
- Do not touch the blade of the paper tear bar (or auto cutter).

DISASSEMBLING PROHIBITED



Do not let water or other foreign objects in the printer.

- If this happens, switch off and unplug the printer before calling your dealer.

PROHIBIT



Do not use the printer when it is out of order. This can cause a fire or an electrocution.

- Switch off and unplug the printer before calling your supplier.

TO UNPLUG



Battery Safety Warning

Please be sure to read this guide prior to use.

Warning

1. If the battery is not charged after the charging time, stop charging and contact the supplier.
2. Store and use the battery where it will not come into contact with liquid (water, salt water, etc.). There may be a risk of overheating, rupturing or igniting.
3. Avoid exposing the battery to high temperatures over 50°C and do not store or use it in a place with high temperature and humidity. There may be a risk of overheating, rupturing or igniting. In addition, it may reduce the performance and life of the battery. There is a risk of explosion, especially when the battery is placed by a fire or stored near a heating device (e.g., heater, etc).
4. Do not put the battery in a microwave oven or high-pressure cooker (pressure cooker, etc.). There may be a risk of overheating, rupturing or igniting.
5. Do not use or leave the battery exposed to direct sunlight or high temperatures such as in a car. It may reduce battery performance and life, or there may be a risk of overheating, rupturing or igniting.
6. The usage temperature range of the battery is as follows. If used outside of this range, battery performance and life may be reduced, or there may be a risk of overheating, rupturing or igniting.
 - Charging: 0 to 40°C (32 to 104°F)
 - Using: -15 to 50°C (5 to 122°F)
 - Long-term storage (over 30 days): -15 to 40°C (5 to 104°F)
7. Be sure to only use an adaptor or charger approved by us to charge the battery. Use of any other adaptor or charger may reduce battery performance and life, or cause a risk of overheating, rupturing or igniting.
8. Do not use the (+) and (-) terminals of the battery reversely. Failure to use the equipment may result in an abnormal chemical reaction inside the battery, which may cause overheating, rupturing or igniting.
9. Do not touch the (+) and (-) terminals of the battery with metal. Also, do not carry or store it with metallic goods (necklaces, hair pins, coins, etc.). There may be a risk of overheating, rupturing or igniting.
10. Do not use the battery in a place where static electricity can be generated. It may damage the device, resulting in reduction of battery performance and life, or there may be a risk of overheating, rupturing or igniting.
11. Avoid causing any strong impact to the battery or throwing it. The protective device inside the battery may be damaged, which may reduce the battery performance and life, or there may be a risk of overheating, rupturing or igniting.

12. Do not disassemble or modify the battery. The battery contains safety and protection devices to prevent danger. It may reduce battery performance and life due to damage, or there may be a risk of overheating, rupturing or igniting.
13. If any leakage of the battery comes into contact with the eyes or skin, immediately rinse with clean water such as tap water and consult a doctor immediately.
14. Keep the battery out of the reach of children and infants. If it is swallowed, consult a doctor immediately.
15. The battery subjected to extremely low air pressure that may result in an explosion or the leakage of flammable liquid or gas.

Recommendations

1. Do not charge for longer than the charging time described in this guide, as it may reduce battery performance and duration.
2. If the battery is not expected to be used for a long time, remove it from the equipment and keep in a place with low humidity.
3. Be sure to turn off the power of the equipment after use. Failure to do so may reduce the performance and life of the battery.
4. Batteries that have not been used for a long time may fail to charge properly. Even if you do not use the battery for a long time, charge it at least once every 6 months whilst storing it.
5. If the (+) and (-) terminals of the battery are contaminated, wipe them with a dry cloth and use in a clean condition. The contamination of battery may result in unstable contact with the equipment and the power may be cut off or the battery may not be charged.

Disposal

1. When using, storing or charging the battery, if you detect any abnormality such as an odour, overheating, discoloration, deformation, leakage, etc., please remove the battery from the equipment or charger and dispose of it immediately.
2. When disposing of the battery, completely discharge it, cover the terminals with insulation tape, and dispose of it at a designated location according to relevant laws and regulations set by the government.

Avertissements de sécurité pour la batterie

Assurer d'avoir bien lu le présent manuel avant d'utiliser le produit.

Avertissement

1. Si la batterie n'est pas chargée après le temps de charge, arrêtez la charge et contactez le fournisseur.
2. Stockez et utilisez la batterie dans un endroit où elle n'entrera pas en contact avec un liquide (eau, eau salée, etc.). Il peut y avoir un risque de surchauffe, de rupture ou d'inflammation.
3. Évitez d'exposer la batterie à des températures élevées sur 50°C et ne la stockez pas ou ne l'utilisez pas dans un endroit où la température et l'humidité sont élevées. Il peut y avoir un risque de surchauffe, de rupture ou d'inflammation. De plus, cela peut réduire les performances et la durée de vie de la batterie. Il existe un risque d'explosion, notamment lorsque la batterie est placée près d'un feu ou stockée à proximité d'un appareil de chauffage (par exemple, un radiateur, etc.).
4. Ne placez pas la batterie dans un four à micro-ondes ou une cocotte-minute (autocuiseur, etc.). Il peut y avoir un risque de surchauffe, de rupture ou d'inflammation.
5. N'utilisez pas ou ne laissez pas la batterie exposée à la lumière directe du soleil ou à des températures élevées, comme dans une voiture. Cela peut réduire les performances et la durée de vie de la batterie ou représenter un risque de surchauffe, de rupture ou d'inflammation.
6. La plage de température d'utilisation de la batterie est la suivante. Une utilisation en dehors de cette plage peut réduire les performances et la durée de vie de la batterie ou représenter un risque de surchauffe, de rupture ou d'inflammation.
 - Charge : 0 à 40°C (32 à 104°F)
 - Utilisation : -15 à 50°C (5 à 122°F)
 - Stockage pour une période prolongée (plus de 30 jours) : -15 à 40°C (5 à 104°F)
7. Veillez à n'utiliser qu'un adaptateur ou un chargeur approuvé par notre entreprise pour charger la batterie. L'utilisation de tout autre adaptateur ou chargeur peut réduire les performances et la durée de vie de la batterie, ou entraîner un risque de surchauffe, de rupture ou d'inflammation.
8. Respectez la polarité (+) et (-) de la batterie. Une mauvaise utilisation de l'équipement peut entraîner une réaction chimique anormale à l'intérieur de la batterie, qui peut provoquer une surchauffe, une rupture ou une inflammation.
9. Ne touchez pas les bornes (+) et (-) de la batterie avec du métal. De même, ne la transportez pas et ne la stockez pas avec des objets métalliques (colliers, épingles à cheveux, pièces de monnaie, etc.). Il peut y avoir un risque de surchauffe, de rupture ou d'inflammation.

10. N'utilisez pas la batterie dans un endroit où de l'électricité statique peut être générée. Cela peut endommager le dispositif, et réduire les performances et la durée de vie de la batterie ou représenter un risque de surchauffe, de rupture ou d'inflammation.
11. Évitez de causer un choc violent à la batterie ou de la jeter. Le dispositif de protection à l'intérieur de la batterie peut être endommagé, ce qui peut réduire les performances et la durée de vie de la batterie ou représenter un risque de surchauffe, de rupture ou d'inflammation.
12. Ne démontez pas ou ne modifiez pas la batterie. La batterie contient des dispositifs de sécurité et de protection pour éviter tout danger. Cela peut réduire les performances et la durée de vie de la batterie, en raison d'une détérioration de cette dernière, ou représenter un risque de surchauffe, de rupture ou d'inflammation.
13. Si un produit qui a fui de la batterie entre en contact avec les yeux ou la peau, rincez immédiatement à l'eau claire, par exemple à l'eau du robinet, et consultez immédiatement un médecin.
14. Gardez la batterie hors de portée des enfants et des bébés. En cas d'ingestion, consultez immédiatement un médecin.
15. La batterie est soumise à une pression d'air extrêmement basse qui peut entraîner une explosion ou une fuite de liquide ou de gaz inflammable.

Recommandations

1. Ne rechargez pas plus longtemps que le temps de charge décrit dans ce guide, car cela peut réduire les performances et la durée de vie de la batterie.
2. Si la batterie ne doit pas être utilisée pendant une longue période, retirez-la de l'appareil et conservez-la dans un endroit peu humide.
3. Veillez à couper l'alimentation de l'équipement après utilisation. Ne pas observer cette recommandation peut réduire les performances et la durée de vie de la batterie.
4. Les batteries qui n'ont pas été utilisées pendant une longue période peuvent ne pas se recharger correctement. Même si vous n'utilisez pas la batterie pendant une période prolongée, rechargez-la au moins une fois tous les 6 mois tout en la stockant.
5. Si les bornes (+) et (-) de la batterie sont contaminées, essuyez-les avec un chiffon sec et utilisez-les dans un état propre. La contamination de la batterie peut entraîner un contact instable avec l'équipement et l'alimentation peut être coupée ou la batterie peut ne pas se charger.

Mise au rebut

1. Lorsque vous utilisez, stockez ou chargez la batterie, si vous détectez une anomalie telle qu'une odeur, une surchauffe, une décoloration, une déformation, une fuite, etc., veuillez retirer la batterie de l'appareil ou du chargeur et la mettre immédiatement au rebut.
2. Lorsque vous mettez la batterie au rebut, déchargez-la complètement, couvrez les bornes avec du ruban isolant et jetez-la dans un endroit dédié conformément aux lois et règlements en vigueur.

1. Content Confirmation

The following items should all be contained in the printer package.
Contact the dealer from which the purchase was made if any item is damaged and/or missing.

※ Basic items



PV4



Battery Pack



Belt Strap

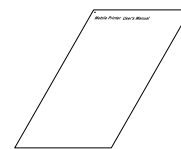

Download Guide

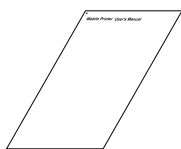

Installation Guide



**Paper Disks
(for 12mm inner
diameter)**

※ Optional items

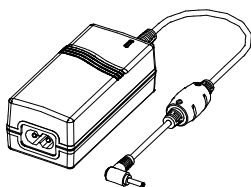

AC/DC Adaptor

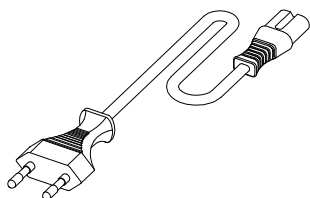

Power Cord



**1CH Battery
Charger**

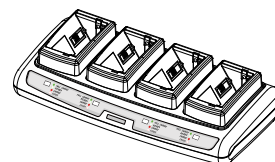

**4CH Battery
Charger**



Serial Cable



USB Cable

2. Product Part Names

• Front

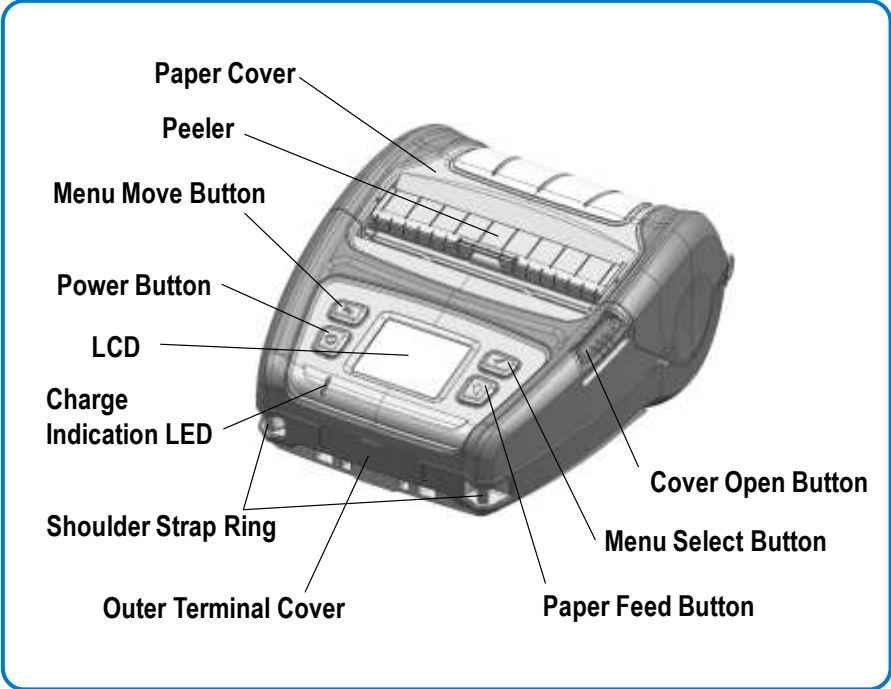

• Rear

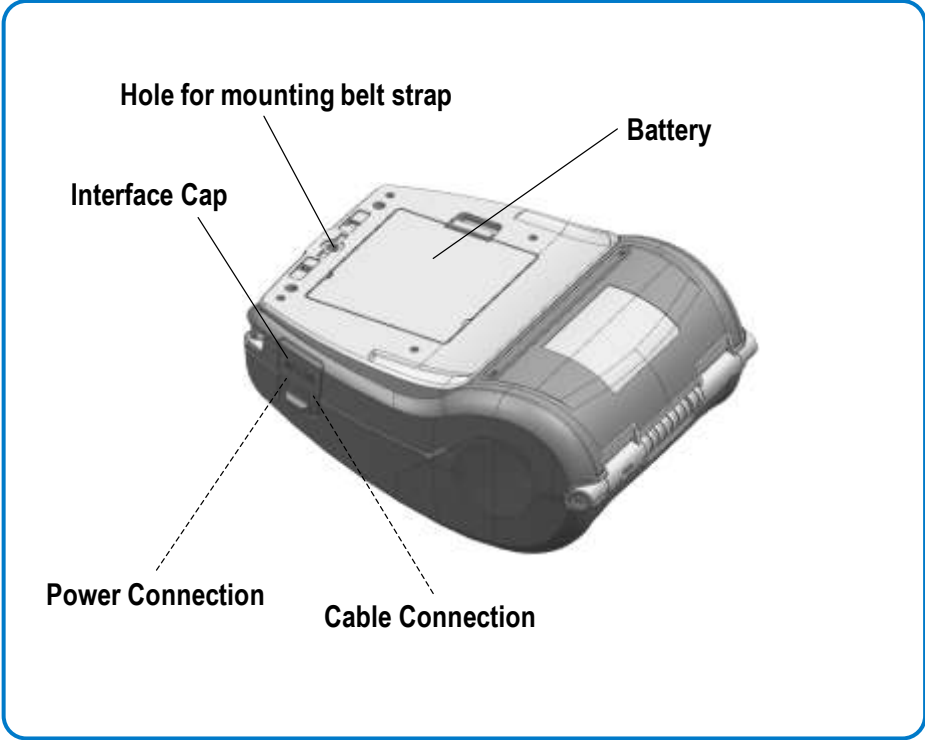

3. Installation & Usage

3-1 Battery Installation



- 1) Insert the battery in the bottom of the printer, and ensure that you align the battery hook properly.
- 2) Push the battery into the slot until you hear it “click” in place.

NOTE

As the battery is partially charged at the time of purchase, charge the battery prior to product use. (Use the AC/DC adaptor or the optional 1CH/4CH battery charger.)

3-2 Battery Charging

3-2-1 Using AC/DC Adaptor



- 1) Turn off the printer power.
- 2) Connect the power cord ② to the AC/DC adaptor ① and then connect AC power.
- 3) Open the external interface cap in the direction of ③.
- 4) Connect the AC/DC adaptor to the power connector.

NOTE

Battery charging status descriptions are as follows.

LED	Charge Status	Charge Time
Red LED On	Charging	Within 6 hours
Green LED On	Fully Charged	
Red LED Blinking	Error Replace or Reinstall Battery	

Caution

The printer may incur serious damage if the AC/DC adaptor provided by SATO is not used. SATO is not legally liable for any such damages. (The voltage and electrical current specifications of the printer and battery charger must match.)

Warning

Turn off the power before charging the battery for the printer.

3-2-2 Using 1CH Battery Charger (Optional)

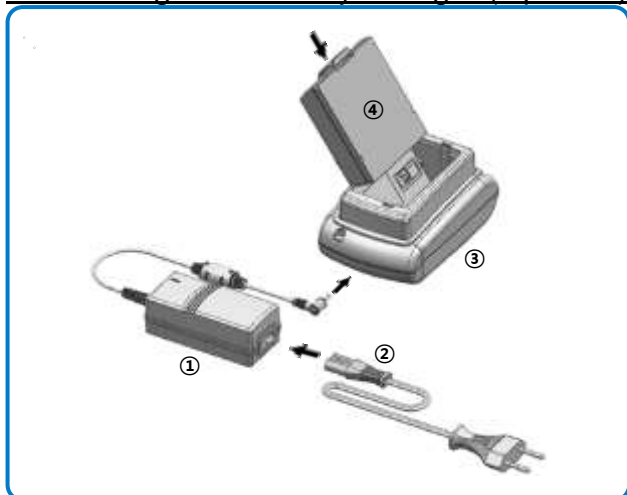

- 1) Connect the power cord ② to the battery charger ①.
- 2) Connect the battery charger ① to the power connector of the cradle ③.
- 3) Plug the power cord ② into an electrical outlet.
- 4) Insert the battery ④ into the cradle ③ a snapping sound is heard.



Caution

- The printer may incur serious damage if you do not use the battery charger provided by SATO when using a single battery charger. SATO is not legally liable for any such damages.
 - You must use the battery charger power supply provided by SATO to use the single battery charger. (AC/DC adaptor is not available)

3-2-3 Using 4CH Battery Charger (Optional)

3-2-3-1 Connecting the cables

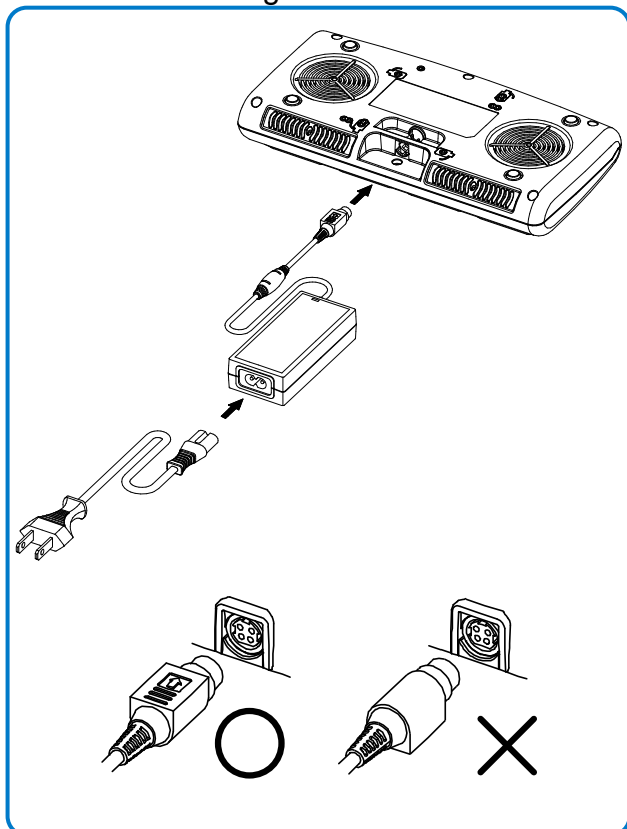

- 1) Connect the power cord to the Adaptor, and Connect the Adaptor to the power connector of the quad battery charger.
- 2) Plug the power cord into a power Outlet. Input power is 100 ~ 240VAC, 50/60Hz, 1.0A.
- 3) When the power is applied, the yellow, green and red LEDs are on for three seconds and do the self-test.



Warning

Use only designated AC/DC Adaptor. (12VDC, 3A)

3-2-3-2 Charging Battery

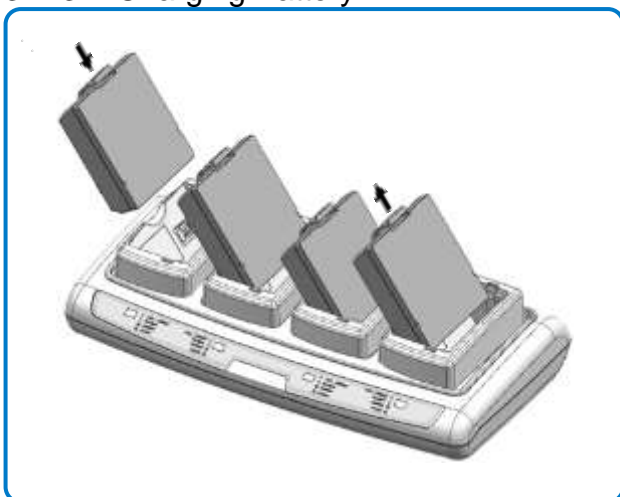

- 1) Insert the battery into the 4CH Battery Charger as shown in the figure on the left.
- 2) Gently slide the battery until it reaches the bottom of the charger.
- 3) Charging starts as soon as the battery is completely inserted.
- 4) After charging, remove the battery from the 4CH Battery Charger.

NOTE

Battery charging status descriptions are as follows.

LED	Charge Status	Charge Time
Red LED On	Charging	Within 10 hours
Green LED Blinking	Over 80% Charged	
Green LED On	Fully Charged	
Red LED Blinking	Error Replace or Reinstall Battery	

 Warning	<ul style="list-style-type: none"> - If the red lamp of the charger blinks, install the battery again. - If the red lamp continues to blink after several attempts (4 ~ 5 times) to install the battery, contact your local dealer. - The charging time may vary depending on the type of the charger or ambient temperature.
--	--

3-3 Paper Installation



1) Press the Open button to open the paper cover.



2) Insert the paper as shown.
(Remove the empty core.)



3) Align the paper as shown.



4) Pull out the paper as shown and close the paper cover.

**NOTE**

The specification of the paper inner diameter of the standard paper disks are 19 mm (0.75 inch). If you are using paper with a smaller inner diameter, remove the paper disks as shown below and replace it with the supplied 12 mm (0.47 inch) paper disks.

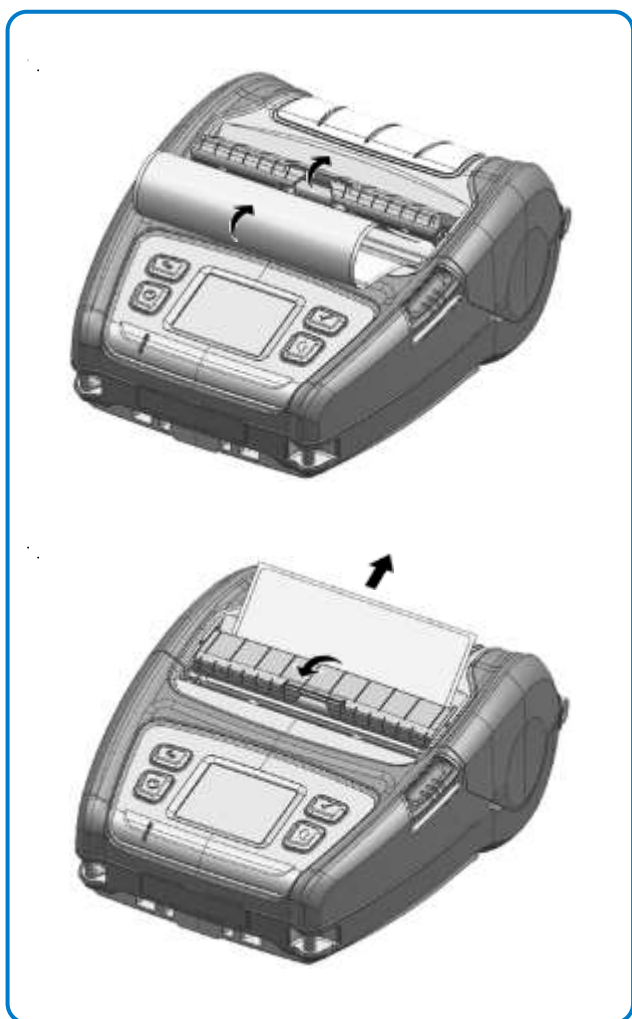
3-4 Using Peeler

1) Insert the paper after open the peeler as shown.

2) Pull out the paper after close the peeler as shown.

NOTE

Enable the peeler setting when using the peeler. Refer to "Sensor setting" of "5. LCD Menu" to enable peeler setting.

3-5 Using Belt Strap

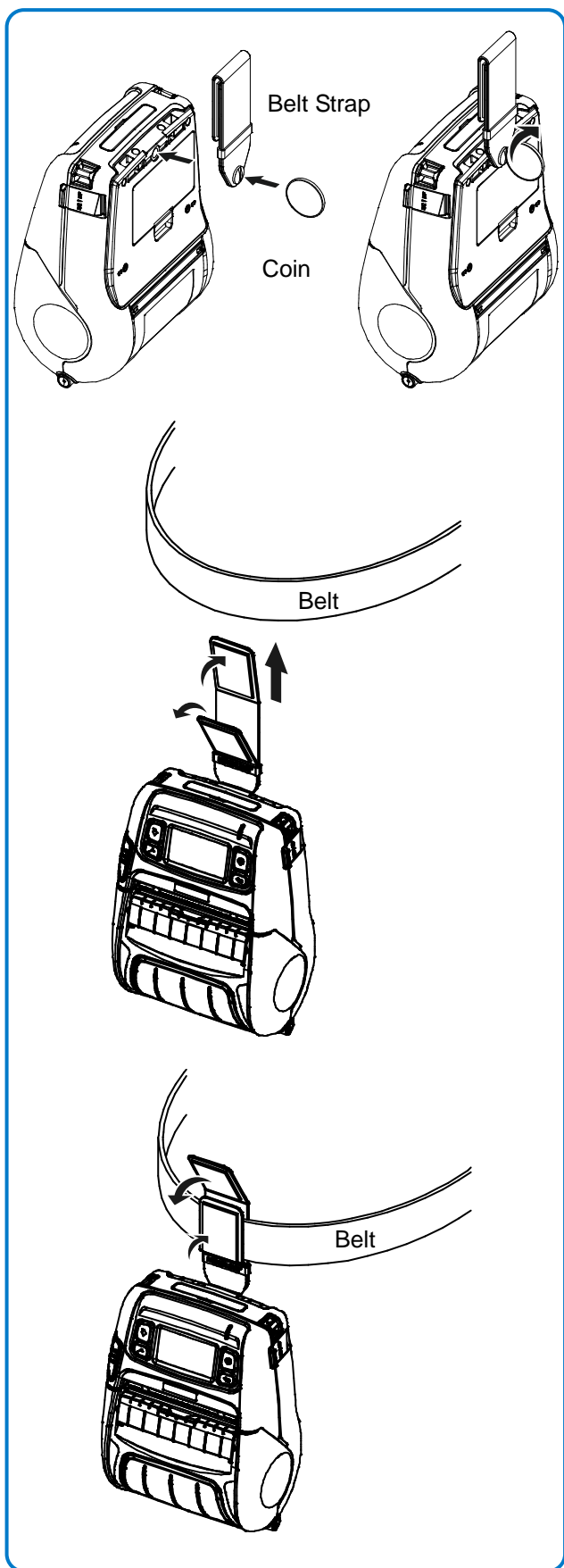

1) Insert the belt strap screw into the belt strap hole.

2) Use a coin to tighten the belt strap screw as shown in the image.

3) Unfasten the belt strap Velcro.

4) Slide the belt strap over a belt.

5) Close the Velcro as shown in the image.

3-6 Using Fan-Fold Paper

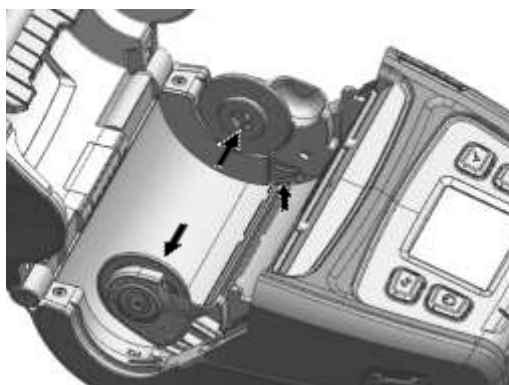

1-1) After keeping the paper holder open wide (as shown), hold the paper holder by lifting right guide holder as shown in the figure.

 **NOTE**

Use only when you are using 105 mm (4.13 inch) paper.

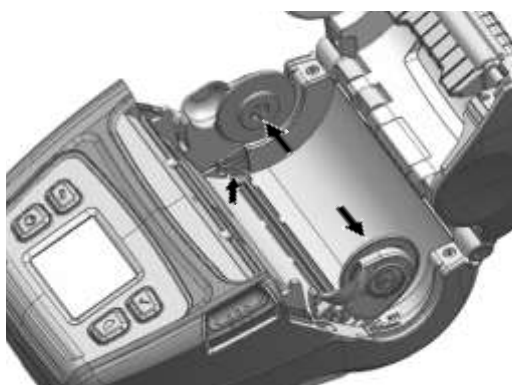

1-2) After keeping the paper holder wide (as shown), hold the paper holder by lifting left guide holder as shown in the figure.

 **NOTE**

Use only when you are using 112 mm (4.41 inch) paper.

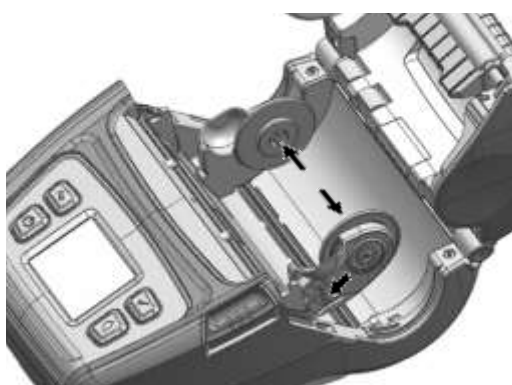

1-3) After keeping the paper holder wide (as shown), hold the paper holder by using the latch as shown in the figure.

 **NOTE**

Use only when you are using 54~110 mm (2.13~3.94 inch) paper.

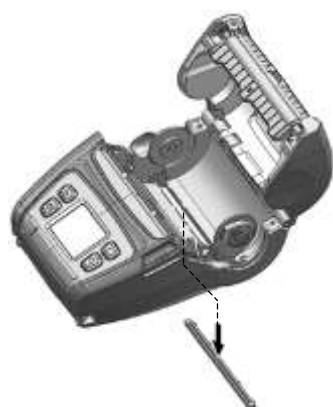

2) Separate the fan-fold cover by pushing as shown in the figure.

3-7 Using Control Panel



• Power Button



This button is used to turn the printer on, off, to move to main menu or to operate the action.

- 1) When the printer is off, press this button for approximately 2 seconds to turn on the power.
- 2) When the printer is on, press this button for approximately 2 seconds to turn off the power.
- 3) Pressing this button while the LCD menu is being operated moves to the main menu or the action selected in the menu is operated.

• Paper Feed Button



This button is used to feed the paper manually or return to the previous step.

- 1) Press and hold this button while the printer is booting to print a self-test page.
- 2) Press this button in the standby mode to feed the paper.
- 3) Press this button to return to the previous menu.

• Menu Move Button



Cycle through the menus.

Press this button to move between the settings menus on the LCD screen

• Menu Select Button



This button is used to select the LCD menu.

Press this button to select the LCD menu or save the selected settings to the printer.

3-9 Recommended Papers

Please contact your local SATO office for media recommendation.

4. Self-Test

Run the self-test to check the setting information when you are setting up the printer for the first time or if there is a problem.

If no issue is found with the printer after running the self-test, examine the other devices or peripherals and software. This function is independent of such other devices and software.

• Self-Test Instructions

- 1) Turn the printer power on and go to the Tool > Print Printer Config menu on the LCD
- 2) Press the power button(Print) to run the self-test.
- 3) The printer settings information is printed on the first page, and the wireless interface information is printed on the next page.
- 4) After the wireless interface information is printed, the self-test is automatically terminated.

• Self-Test Sample

SATO PV4 CONFIGURATION	
FIRMWARE VERSION	: V01.00 STD 010118
EMULATION	: SLCS & BPL-Z & BPL-C
PRINT DARKNESS	: 0/30
PRINT SPEED	: 5 IPS
TEAR OFF VALUE	: +000 DOT
TEAR OPTION	: TEAR-OFF
PRINT OFFSET	: +0000 DOT
POWER-UP ACTION	: NO ACTION
MEDIA TYPE	: BLACKMARK MEDIA(REAR)
SENSOR TYPE	: REAR REFLECT
PRINT METHOD	: DIRECT THERMAL
LABEL LENGTH	: 1013 DOT
LABEL WIDTH	: 576 DOT
BAUD RATE	: 115200
PARITY	: NONE
DATA BIT(S)	: 8
STOP BIT(S)	: 1
HAND SHAKING	: HARDWARE
USB SERIAL NUMBER	: 0000000000001
BPL-Z CODEPAGE	: CP-850(SBE. USA-1 CHARSET)
SLCS CODEPAGE	: WCP1252-LATIN1
SLCS ICS	: U.S.A
CONFIGURATION CONTROL STATUS	
PRINT SPEED	: COMMAND
PRINT DARKNESS	: COMMAND
PRINT WIDTH	: COMMAND
PRINT OFFSET	: COMMAND
TEAR OFF	: COMMAND
MEDIA TYPE	: COMMAND
LANGUAGE	: COMMAND

(Bluetooth)

RF INTERFACE STATUS (BT)

BLUETOOTH F/W VER : 2.0.4
MAC ADDRESS



74F07DE3D121

FRIENDLY NAME : PV4
MODE : CLASSIC
AUTH & ENCRYPT : ENABLED
CONNECTION MODE : 2

(Wireless LAN)

RF INTERFACE STATUS (WLAN)

WLAN F/W VER : 02.02(4002)
MAC ADDRESS



74F07DE3D121

SYSTEM NAME : PV4
NETWORK MODE : SOFT AP
FREQUENCY : (PRIORITY)2.4GHZ/5GHZ
AUTHENTICATION : OPEN
ENCRYPTION : NONE
ESSID : PRINTER_E3D121
DHCP : DISABLED
IP ADDRESS : 192.168.1.1
NETMASK : 255.255.255.0
GATEWAY : 192.168.1.2
PORT : 9100
INACTIVITY TIME : 10 SEC

5. LCD Menu





You can check printer status and setting information through LCD.





• Top icon

Icon	Description
	Bluetooth is enabled but not connected to the host device
	Bluetooth is enabled and connected to the host device
	Display signal strength of wireless LAN
	Can not searching the registered AP
	Authentication failed
	LAN is enabled and connected
	Receiving data, printing or media feed
	Media empty
	Media cover open
	TPH (Thermal Print head) overheating
	Battery status

• Main menu icon

Icon	Description
	Check / set the status of whole printer 1) Interface 2) Media 3) Sensor 4) Powersave 5) Language
	Media settings 1) Density 2) Position - Tear off - Print - Direction
	Tools 1) Hex dump 2) Print printer config → Self test 3) Print test pattern 4) Printer factory reset
	Check / set the status of the interface 1) Bluetooth - On/Off - SSP (Secure Simple Pairing) / PIN code mode setting - BLE / Classic mode setting - Information (Name, MAC address) 2) Wireless LAN - On/Off - Information (SSID, Mode, Encryption, IP, Port, MAC address, Inactivity time) - Smart connection (easy connection to AP by linking with smart connection APP) - Factory reset 3) LAN - On/Off - Information (IP, Port, MAC address, Inactivity time)
	Check the battery status

Icon	Description
	<p>Check printer information</p> <ol style="list-style-type: none"> 1) Version <ul style="list-style-type: none"> - Printer, WLAN, Bluetooth 2) Bluetooth 3) WLAN 4) LAN 5) Battery 6) Repair
	<p>Sensor settings</p> <ol style="list-style-type: none"> 1) Media type <ul style="list-style-type: none"> - Auto detection / Rear black mark / Gap - Continuous 2) Peeler <ul style="list-style-type: none"> - On/Off - Sensor sensitivity adjustment
	<p>Set Backlight, Sleep and Power off Time</p> <ol style="list-style-type: none"> 1) Backlight brightness 2) Backlight off time 3) Sleep time 4) Power off time

6. Peripherals Connection

This product can communicate with other devices via Bluetooth, Wireless LAN communication and cable.

6-1 Bluetooth, Wireless LAN Connection

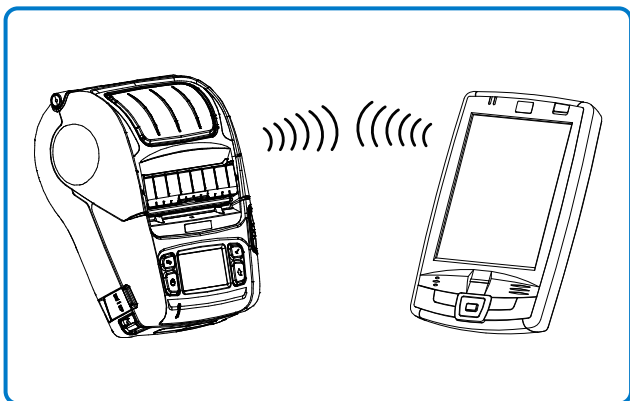

- 1) The printer can be connected to devices equipped with Bluetooth communication capacity (PDAs, PCs, etc.).
- 2) Use the Bluetooth connection function supported by the device to connect to the printer.
The NFC tag built into the printer enables automatic pairing with devices.

NOTE

Tap your host device to logo on the side of the printer for NFC auto pairing



NOTE

The device must support NFC Auto Pairing. It may display a message that the device cannot be connected as NFC Auto Pairing is supported up to the Bluetooth pairing and the devices must be connected manually, but this is normal.

- 3) The printer can be connected to other stations, such as PDAs and PCs supporting wireless LAN communication in Ad-hoc mode, Soft AP mode and AP in Infrastructure mode.

NOTE

Refer to the Bluetooth Wireless LAN Manual for detailed information on its connection. You can check the Bluetooth environment (authentication, encryption, connection mode) and the Wireless LAN environment (IP, SSID, authentication, encryption) via the self-test page.

6-2 Interface Cable Connection



- 1) Open the Interface Cap ①.
- 2) Connect the external communication cable ② to the cable connector of the printer.
- 3) Connect the interface cable to the USB connector of the device (PDAs, PCs, etc.).

NOTE

The interface cable for the printer is either a Serial/USB cable provided by SATO (optional) or USB Type-C cable supporting USB2.0.

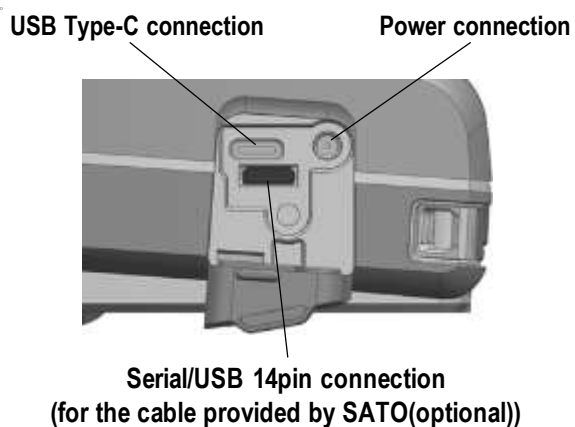

6-3 Fixed Interface Cable Connection



- 1) Open the Interface Cap ①.
- 2) Connect the external communication cable (optional) ② to the cable port of the printer.
- 3) Fix the interface cable by tightening the screw ③ as shown in the figure.
- 4) Connect the interface cable to the USB port of the device (PDAs, PCs, etc.).

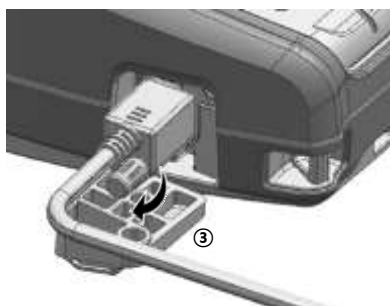

NOTE

The fixed interface cable that can be connected to the printer is a Serial/USB cable provided by SATO(optional).

7. Printer Cleaning

If the interior of the printer is dusty, print quality can be impaired. In such a case, follow the instructions below to clean the printer.

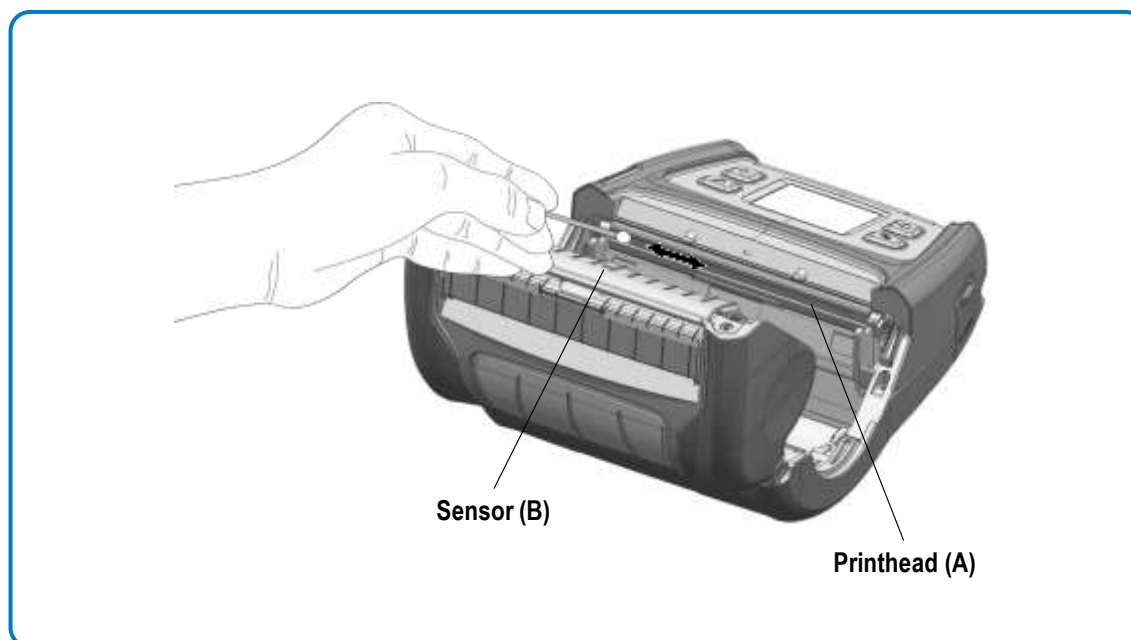

- 1) Open the paper cover and remove the paper, if present.
- 2) Clean the print head (A) using a cloth or cotton swab soaked in medical grade alcohol. Apply the cloth or cotton swab from the center to the edge of the print head (A) for cleaning.
- 3) Using a cloth or cotton swab soaked in medical grade alcohol, remove the paper dust from the black mark sensor (B).
(Sensor could be located in the middle or on left or on right)
- 4) Do not use the printer for 10 minutes after cleaning the print head (A) until the cleaning agent has completely evaporated and dried.
- 5) Insert the paper and close the paper cover.



Caution

- Make sure the printer power is turned off before cleaning.
- Wait for two to three minutes after power-off before print head cleaning because it may be very hot.
- Do not touch the heating region of the print head with your hand while cleaning it.
- The print head may be damaged by static electricity.
- Avoid scratching the print head.

8. Appendix

8-1 Specifications

Item	Description	
Printing	Printing Method	Thermal Printing
	Print Speed	Up to 127 mm/s (5 ips)
	Resolution	203 dpi
	Font	10 SLCS Resident Bitmap Fonts One SLCS Resident Scalable Font 16 BPL-Z™ Resident Bitmap Fonts One BPL-Z™ Resident Scalable Font 7 BPL-C™ Resident Bitmap Fonts 23 Code Page Unicode supported (UTF-8, UTF-16LE, UTF-16BE)
	Barcode	1D: Codabar, Code 11, Code 39, Code 93, Code 128, EAN-13, EAN-8, Industrial 2-of-5, Interleaved 2-of-5, Logmars, MSI, Plessey, Postnet, GS1 DataBar (RSS-14), Standard 2-of-5, UPC/EAN extensions, UPC-A, UPC-E, IMB 2D: Aztec, Codablock, Code 49, Data Matrix, MaxiCode, MicroPDF417, PDF417, QR code, TLC 39
	Emulation	SLCS, BPL-Z™, BPL-C™
	Sensor	Gap Sensor, Black Mark Sensor, Paper Cover Open Sensor, Label Presence Sensor
	Cutter Type	Tear-Bar
Paper	Paper Shape	Label Paper
	Paper Type	Thermal Paper
	Outer Diameter of Paper Roll	Max. Ø66 mm (2.60 inch)
	Width	50 ~ 112 mm (1.97 ~ 4.41 inch)
	Thickness	0.07~0.15 mm
Reliability	Printer	25 km (Label Paper), 10 km (Linerless Paper)
	Battery	Rechargeable up to 300 times
Communications	Interface	Serial / USB, Bluetooth V5.0(Classic / LE), NFC Auto pairing Wireless LAN 802.11 a/b/g/n * Wireless communication is enabled only for devices with Bluetooth or Wireless LAN function.
AC/DC Adaptor	Input	Voltage: 100 ~ 240 VAC, 50/60 Hz Current: 1 A
	Output	Voltage: 9 VDC Current: 2 A
	Model	P24A090200: Something High Electric (Xiamen) Company Inc.
Battery	Type	Lithium-ion
	Output	Voltage: 7.4 VDC (Available 8.4 ~ 6.8 VDC) Capacity: 6700 mAh
	Charging Time	Within 6 hours * Charging current and charging time may depend on the type (optional) of charger.
Usage Conditions	Temperature	Printer Operating : -15 ~ 50 °C (5 ~ 122 °F) Printer Storage : -30 ~ 70 °C (-22 ~ 158 °F) Charging: 0 ~ 40 °C (32 ~ 104 °F) *Refer to the temperature conditions on page 9
	Humidity	Printer Operating : 10 ~ 80 % RH (No condensation) Printer Storage : 10 ~ 90 % RH (No condensation) Battery: 20 ~ 70 % RH (No condensation) *Refer to the temperature conditions on page 9
Dimensions	Printer	158 x 186 x 82 mm (6.23 x 7.33 x 3.23 inch)
Weight	Printer	Printer: approx. 850 g (1.88 lbs) Printer+Battery: approx. 1,090 g (2.41 lbs) Printer+Battery+Paper: approx. 1,450 g (3.20 lbs) Package: approx. 1,740 g (3.84 lbs)
Accessories	Basic Package	Battery Pack, Belt Strap, Download Guide, Installation Guide, Paper Disks
	Sold Separately	AC/DC Adaptor, 1CH Battery Charger, 4CH Battery Charger, Serial Cable, USB Cable

8-2 Label Types

- The labels used on this product are composed of the following materials;
 - SATO logo label: PC
 - Rating Label: PET
 - Other labels: PET

Copyright

© SATO CORPORATION. All rights reserved.

This user manual and all property of the product are protected under copyright law. It is strictly prohibited to copy, store, and transmit the whole or any part of the manual and any property of the product without the prior written approval of SATO CORPORATION. The information contained herein is designed only for use with this SATO product. SATO is not responsible for any direct or indirect damages, arising from or related to use of this information.

- The SATO logo is the registered trademark of SATO CORPORATION.
- All other brand or product names are trademarks of their respective companies or organizations.

SATO maintains ongoing efforts to enhance and upgrade the functions and quality of all our products.

In the following, product specifications and/or user manual content may be changed without prior notice.

Warning - U.S.A

This equipment has been tested and found to comply with the limits for a Class A digital device pursuant to Part 15 of the FCC Rules. These limits are designed to provide reasonable protection against harmful interference when the equipment is operated in a commercial environment. This equipment generates uses, and can radiate radio frequency energy and, if not installed and used in accordance with the instruction manual, may cause harmful interference to radio communications. Operation of this equipment in a residential area is likely to cause harmful interference in which case the user will be required to correct the interference at his own expense.

ii) Changes or modifications not expressly approved by the manufacturer could void the user's authority to operate the equipment.

iii) Caution: Exposure to Radio Frequency Radiation.

To comply with FCC RF exposure compliance requirements, a separation distance of at least 20 cm must be maintained between the antenna of this device and all persons.

Notice - Canada

i) Class A Digital Device : Wired Device

This Apparatus complies with class "A" limits for radio interference as specified in the Canadian department of communications radio interference regulations.

Get appareil est conforme aux normes class "A" d'interference radio tel que specifier par ministre canadien des communications dans les reglements d'interference radio.

Caution

Some semiconductor devices are easily damaged by static electricity. You should turn the printer “OFF”, before you connect or remove the cables on the rear side, in order to guard the printer against the static electricity. If the printer is damaged by the static electricity, you should turn the printer “OFF”.

Waste Electrical and Electric Equipment (WEEE)



This marking shown on the product or its literature, indicates that it should not be disposed with other household wastes at the end of its working life. To prevent possible harm to the environment or human health from uncontrolled waste disposal, please separate this from other types of wastes and recycle it responsibly to promote the sustainable reuse of material resources. Household users should contact either the retailer where they purchased this product, or their local government office, for details of where and how they can take this item for environmentally safe recycling. Business users should contact their supplier and check the terms and conditions of the purchase contract. This product should not be mixed with other commercial wastes for disposal.

